

# Denver Basic 1320 F6

Flame Tray 1100mm

with remote control, bluetooth, app and six step flame levels incl. external pump  
with 70x10mm low glass (in front of burner)

**Please Note**, if using **the minimum** required dimensions for the wall cut-out, the wall in front of the safety chamber becomes very thin, only 7,5mm.

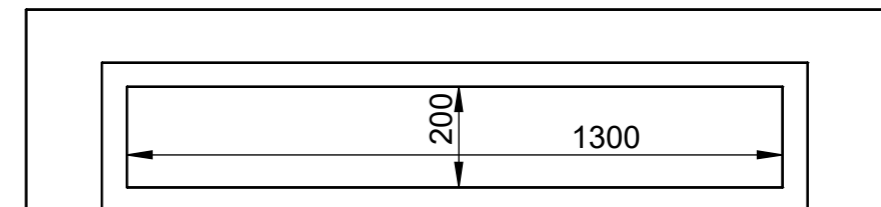
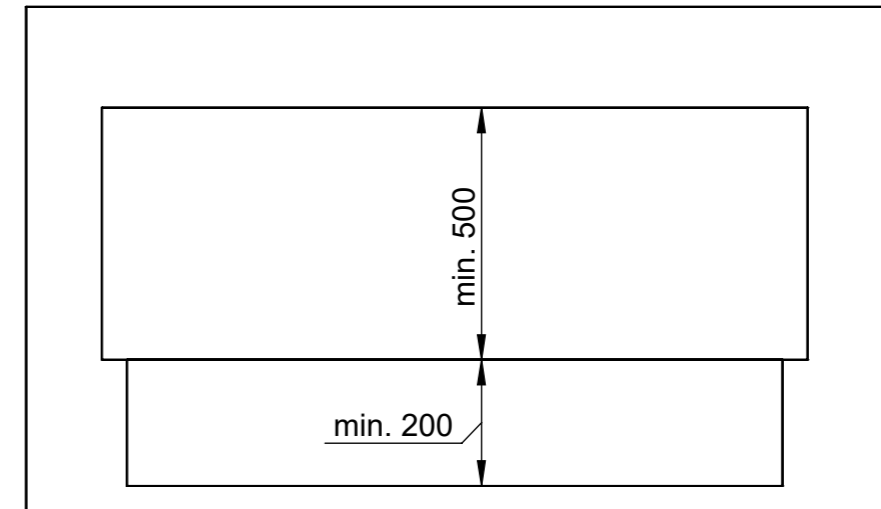
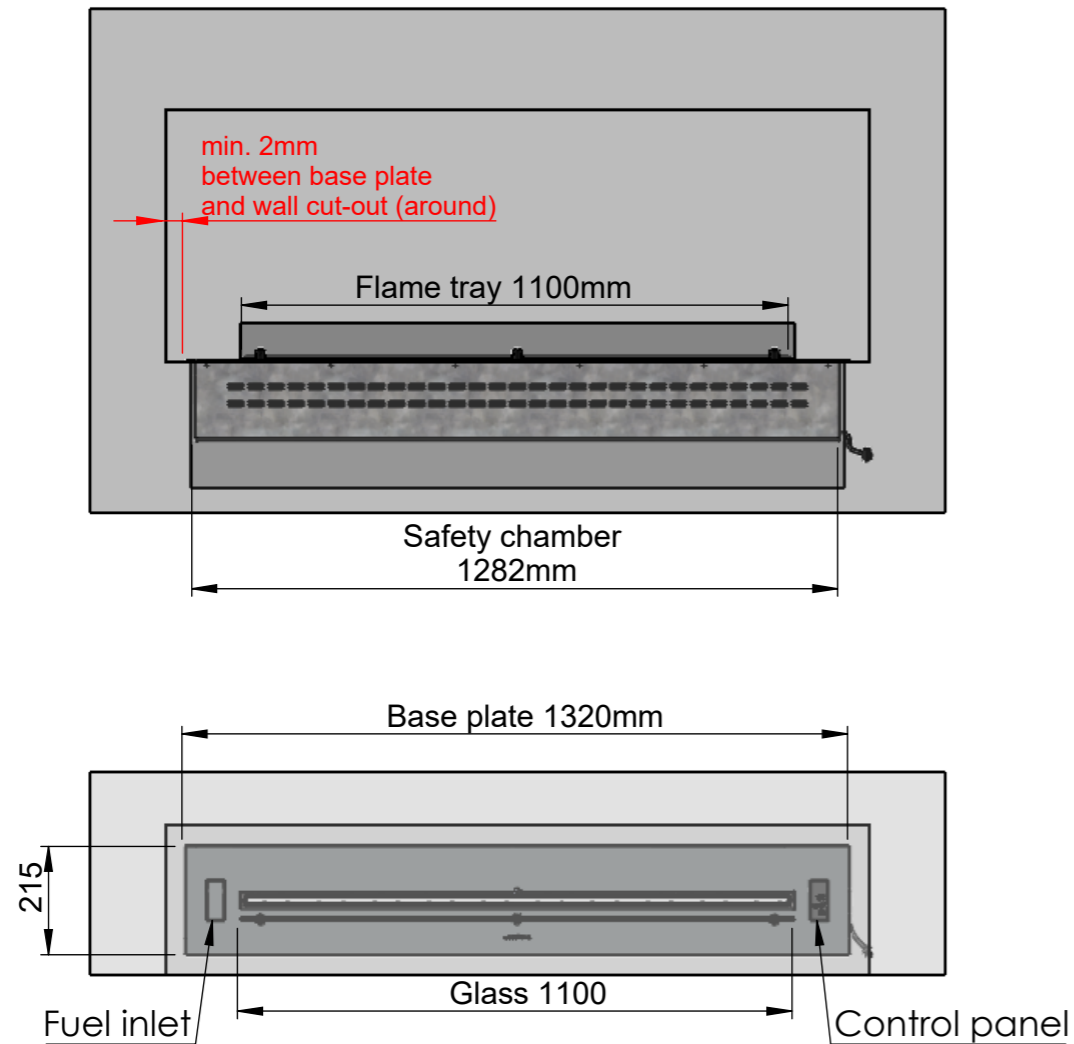

**Mounting**, if top plate is to rest on top of surrounding surface Note: base plate can get hot! Ensure that the surrounding surface can withstand a temperature of around 50 degrees C.

<b>Dimensions are in millimeters</b>		Decoflame Aps Vang Mark 2 9380 Vestbjerg Denmark Tlf: +45 9630 4800		<b>SCALE: 1:50</b>
Date	29-09-2023			FORMAT: A3
REVISION:		bestilling@decoflame.dk		Page 1 OF 3
Author:	TTK	Order Number - Customer - Reference: PRINCIPLE Denver Basic 1320 F6 - FT1100 - 1320x215x160mm - 1x 70 glass		
Copyright of Decoflame ApS Denmark, whose property this document remains. No part thereof may be disclosed, copied, duplicated or in any other way made use of, except with the approval of Decoflame ApS.		Customer Approval Signature - Date		

# IMPORTANT INFORMATION

Particulars of the wall in which the fireplace shall be installed

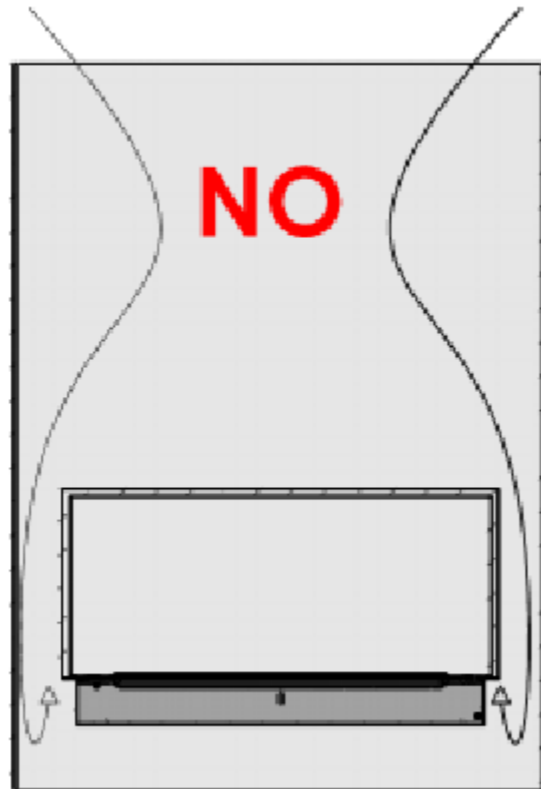

**DO NOT!** install the fireplace in a wall construction which is open above and below the fireplace. The warm air will cause turbulences inside this hollow construction which will have a negative impact on the flames.

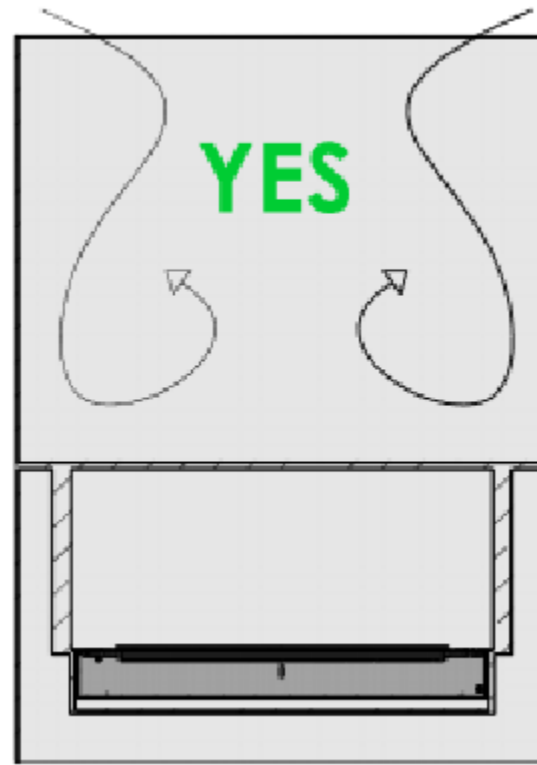

**DO!** install the fireplace in an open-wall construction, which is closed above and below the fireplace. Make sure to create a closed cavity for the section below the base plate of the fire.

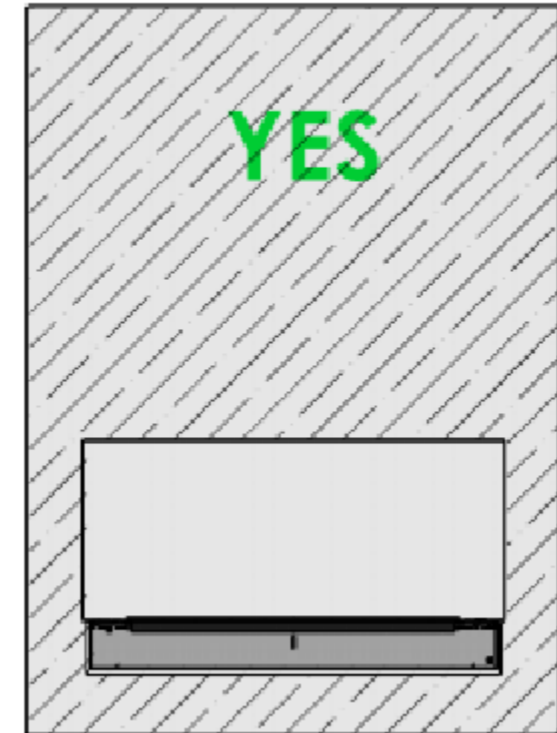

**DO!** install the fireplace in a massive wall (made of bricks, stone or gas beton) using the wall cut-out dimensions mentioned on the previous page.

<b>Dimensions are in millimeters</b>		Decoflame ApS Vang Mark 2 9380 Vestbjerg Denmark Tlf: +45 9630 4800		<b>SCALE: 1:50</b>
Date	29-09-2023	bestilling@decoflame.dk		FORMAT: A3
REVISION:		Order Number - Customer - Reference:		Page 2 OF 3
Author:	TTK	PRINCIPLE Denver Basic 1320 F6 - FT1100 - 1320x215x160mm - 1x 70 glass		
Copyright of Decoflame ApS Denmark, whose property this document remains. No part thereof may be disclosed, copied, duplicated or in any other way made use of, except with the approval of Decoflame ApS.		Customer Approval Signature - Date		

## PEJSEHUL / FIREPLACEHOLE

Pejsehullet skal være konstrueret i brandhæmmende materiale i forhold til DS/EN 13501-2. Biopejsvæggen skal være med en BS-konstruktion. Materialet skal overholde minimum A2-s1, d0.

Pejsehullet skal være hermetisk lukket i både top og sider, således at der ikke opstår falsk gennemtræk.

Dette gælder også ledningsudtaget, hvor der enten fuges omkring ledningen eller tillukkes med brandhæmmende skum.

Decoflame anbefaler, at man **IKKE** fuger omkring pejsens casing. Den 5mm skyggekant sikrer, at pejsen både kan ventilere og isolere, således en varmevandring i væggen minimeres. Derudover kan fugen på sigt risikere at krakelere og/eller misfarves.

The fireplace hole must be constructed in a non-flammable material with regard to DS / EN 13501-2. The biofireplace wall must have a BS construction. Here, the material must meet the minimum A2-s1, d0, e.g. concrete or plaster.

The fireplace hole must be **hermetically sealed** in both top and sides, so that false drafts cannot occur. This also applies to the cable outlet, where it is either grouted around the cable or closed with non-flammable foam.

Decoflame recommends that you do NOT joint around the casing of the fireplace. The 5mm shade edge ensures that the fireplace can both ventilate and insulate, so that heat migration in the wall is minimized. In addition, there is a risk that the joint will crack and / or discolor during time.

### IKKE GODKENDT / NOT APPROVED (1-4)

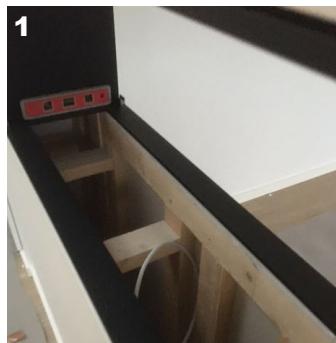

1 Hullet til brænderen er beklædt med træ / The hole for the burner is lined with wood.



2 For stort et hul omkring ledningshullet, skulle have været fuget / Too much space around the wiring, must be grouted.



3 Pejsevæggen er ikke sikret mod falsk træk i siderne / The fireplace wall is not secured against false draft in the sides.



4 Væggen er ikke hermetisk lukket for nederen, der kan komme træk / The wall is not hermetically sealed at the bottom, which can cause drafts.

### GODKENDT / APPROVED (5-8)



5 Pejsevæg lukket i top og sider / The fireplace wall closed at the top and sides.



6 Strømsik 3-benet (Jord) / Power plug 3-pin (Ground).



7 Alle krydsmaal skal være i vinkel / All cross-measures must be at an angle.



8 De 2 vægge skal være i vatter / The 2 wall must be in level.

## VIGTIGT / IMPORTANT

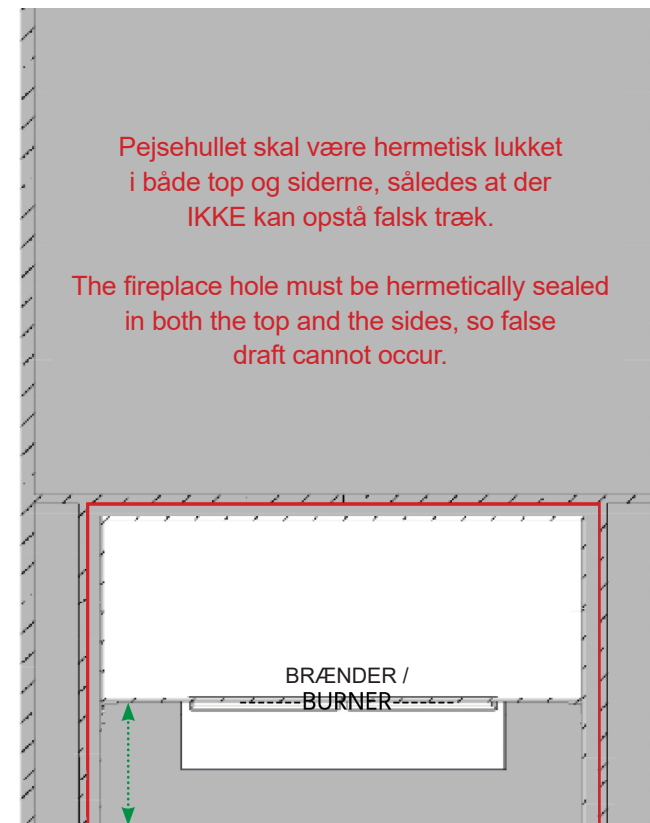

Hulmuren nedadtil (til gulv) må max. være 1000mm i dyben - minimum 200mm.

The cavity wall downwards (to the floor) must max. be 1000mm in depth - minimum 200mm.

Dimensioner i mm. / Dimensions in mm. 3/3

Decoflame Aps  
Vang Mark 2  
9380 Vestbjerg  
Denmark  
Tlf: +45 9630 4800



bestilling@decoflame.dk

Copyright of Decoflame ApS Denmark, whose property this document remains. No part thereof may be disclosed, copied, duplicated or in any other way made use of, except with the approval of Decoflame ApS Decoflame Denmark.