



Q-Tee II Q-Tee II C

BRUGERVEJLEDNING
BEDIENUNGSANLEITUNG
USER MANUAL
MANUEL D'UTILISATEUR
BRUKERVEILEDNING
BRUKSANVISNING
KÄYTTÖOHJE
GEBRUIKERHANDLEIDING

RAIS[®]
ART OF FIRE

attika[®]
FEUERKULTUR

The production number can be found on the back of the stove.

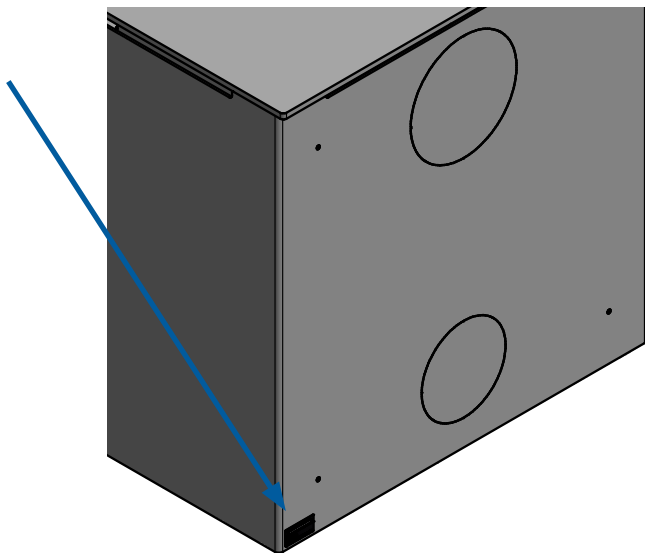

CONTENTS

Installation manual	4
In general	4
Chimney	4
Technical data	5
Specifications	5
Dimensional sketches	6
Information plate	10
Installation	12
Delivery packaging	12
Disposal of packaging	12
Installation instructions	13
Chimney	14
Installation	15
Installation distances	18
Height adjustment	22
Fitting/changing the handle	23
Removing the combustion chamber lining	24
Lubricating hinges	25
installation of smoke outlet for rear outlet	26
Test certificate	27

This manual applies to the following models:

- Q-Tee II Glass
- Q-Tee II Classic
- Q-Tee II C Glass
- Q-Tee II C Classic

INSTALLATION MANUAL

Thank you for choosing your new RAIS or ATTIKA product! This installation manual will ensure that your wood stove is installed correctly and that it will provide you with comfort and pleasure for many years to come.

IN GENERAL

It is important to correctly install the wood stove out of consideration for both the environment and personal safety. The installation of the stove must comply with all local rules and regulations, including those that refer to national and European standards. A certified chimney sweeper should be contacted before the installation is started.

No unauthorised alterations may be made to the wood stove.

GENERAL INSTALLATION REQUIREMENTS

Before the fireplace insert may be put to use, the installation must be reported to your local chimney sweeper.

There must be a plentiful supply of fresh air in the installation room to ensure good combustion – if required, through an Air-System connection. NB: Any mechanical air extraction, for example a cooker hood, can minimise the supply of air.

The wood-burning stove has an air consumption of at least 7,4 m3/h.

The floor structure must be able to support the weight of the wood-burning stove and a chimney. If the existing floor structure does not meet this requirement, suitable measures must be taken (e.g. installation of a load distribution plate). Seek advice from a building expert.

If the wood-burning stove is to be installed on a flammable floor, national and

local regulations must be complied with, including for the size of the non-flammable plate, which must cover the floor in front of the wood-burning stove to protect the floor from any embers that fall out of the stove.

The wood stove must be positioned at a safe distance from flammable material. Due to risk of fire, flammable items (e.g. furniture) may not be positioned closer to the wood stove than the closest permitted distance stated in the installation section. When deciding where to install your RAIS/ATTIKA wood stove, you should think about being able to heat other rooms in the home, so you get the most out of your new wood stove.

After receiving your wood stove, please check it for any defects.

CHIMNEY

The chimney must be tall enough to ensure correct draught conditions, i.e. -14 to -18 pascal. If the recommended chimney draught cannot be achieved, problems from smoke escaping from the door may arise when lighting the fire. We recommend adapting the chimney to suit the flue outlet connector. The flue outlet connector is 150 mm in diameter.

If the draught is excessive, it is recommended that you equip the chimney with a regulating damper. If a regulating damper is fitted, you must ensure that there is a free flow area of at least 20 cm² at the closed regulating damper.

Remember that there must be unobstructed access to the access door on the chimney.

TECHNICAL DATA

The technical data given below includes specifications, dimensional drawings and the information plate.

SPECIFICATIONS		
Danish Technological Institute ref.: 300-ELAB-1882-EN / 300-ELAB-1882-NS		
	Q-Tee II	Q-Tee II C
Nominal output (kW)	6,5	6,5
Min./Max. Output (kW):	3-8 *	3-8 *
Heating area (m ²)	45 - 120	45 - 120
Fireplace insert width/depth/height (mm)	582 / 410 / 598	660 / 479 / 598
Combustion chamber W x D x H (mm)	446 / 277 / 167**	446 / 277 / 167**
Min. uptake (pascal)	-12	-12
Weight (kg) min., depending on the model:		
Efficiency (%)	81	81
CO emission attributed to 13% O ₂ (%)	0,0791 (989 mg/Nm ³)	0,0791 (989 mg/Nm ³)
NO _x emission attributed to 13% O ₂ (mg/Nm ³)	81	81
Particle emission in accordance with NS3058/3059 (g/kg)	1,868	1,868
Dust measurement in accordance with DIN + 13% O ₂ (mg/Nm ³)	14	14
Flue gas flow (g/s)	5,2	5,2
Flue gas temperature (°C)	263	263
Recommended amount of wood (kg) when stoking the fire (Distributed between 2 logs, each max. 24 cm)	1,8	1,8
Intermittent operation Stoking should be done within	60 minutter	60 minutter

The fireplace insert is tested and approved by:

*Not verified by test.

**Max. load

DTI
 Danish Technological Institute
 Teknologiparken Kongsvang Allé 29
 8000 Aarhus C
 Denmark
 www.dti.dk
 Tel.: +45 7220 2000
 Fax: +45 7220 1019

DIMENSIONAL SKETCHES

Q-Tee II
Glass door
8426567

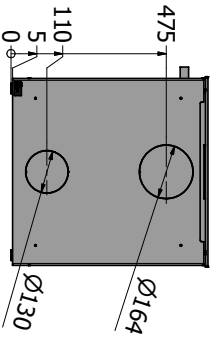
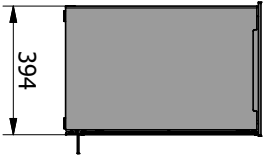
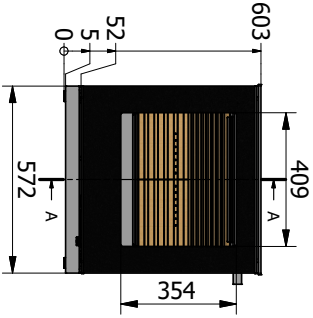
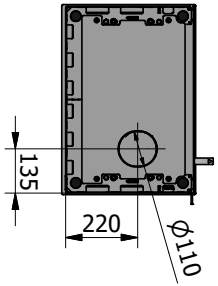

A-A

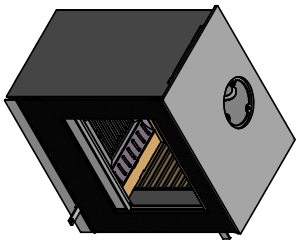
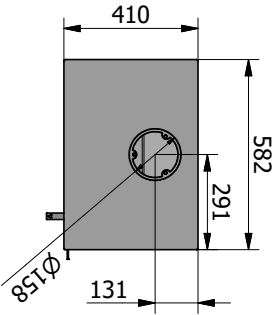

DIMENSIONAL SKETCHES

Q-Tee II
Classic door
8426568

GB

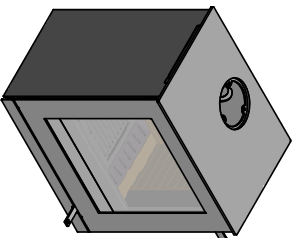
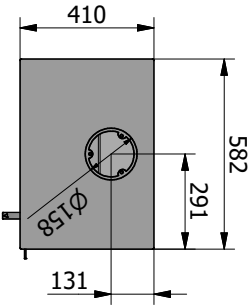
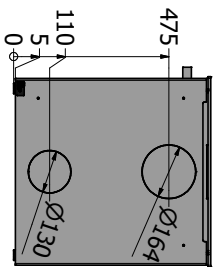
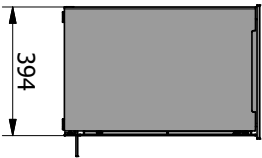
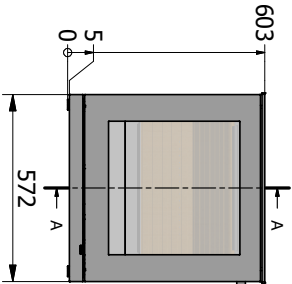
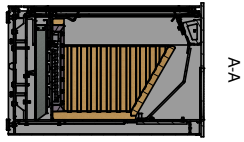
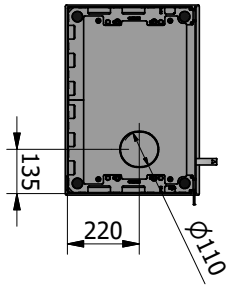

DIMENSIONAL SKETCHES

Q-Tee II C
Glass door
8346567

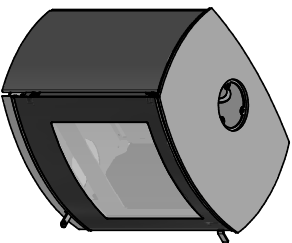
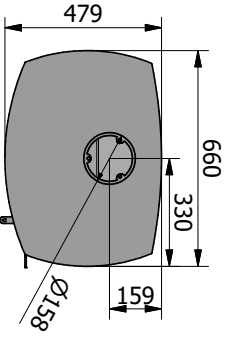
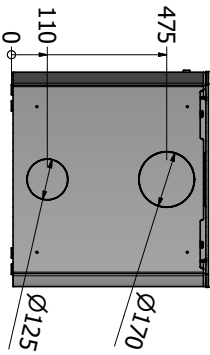
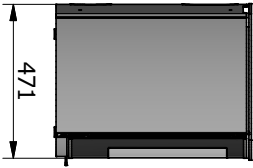
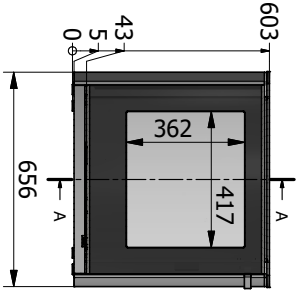
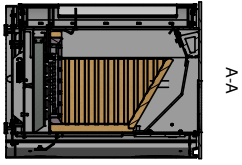
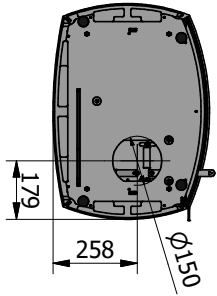

Q-Tee II C
Classic door
8346568

RAIS® **attika**®
ART OF FIRE FEUERKULTUR

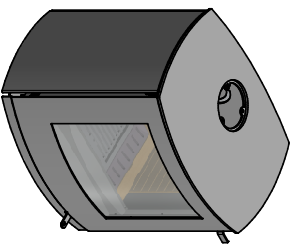
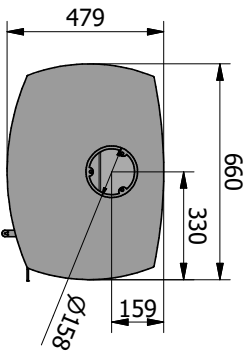
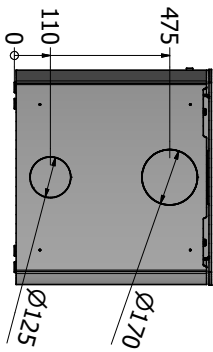
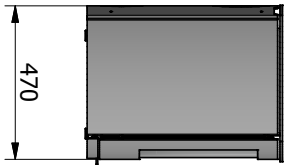
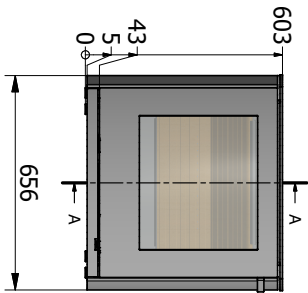
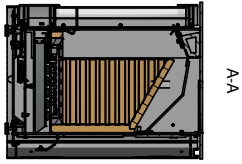
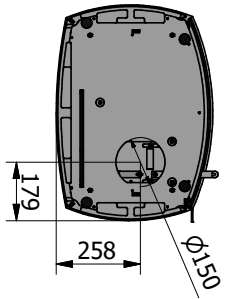

Information plate

All RAIS/ATTIKA wood-burning stoves have an information plate which states the stove's distance from flammable materials, efficiency, etc. The information plate is laid loose with the stove on delivery. We recommend that you fit the information plate on the rear of the wood-burning stove.

	
Notified Body: 1235	
Produced at: RAIS A/S, Industrivej 20, 9900 Frederikshavn, Danmark	
EN 13240:2001+A2:2004 EC.NO: 838	17 Q-Tee II / Q-Tee II C / Q-Tee II C SST
Raumheizer für feste Brennstoffe Appliance fired by wood Poêle pour combustibles solides	
AFSTAND TIL BRÆNDBART, BAGVÆG ABSTAND ZU BRENNBAREN BAUTEILEN, HINTEN DISTANCE TO COMBUSTIBLE BACK WALL DIST. ENTRE COMPOSANTS COMBUSTIBLES, ARRIÈRE AFSTAND TIL BRÆNDBART, SIDEVÆG ABSTAND ZU BRENNBAREN BAUTEILEN, SEITE DISTANCE TO COMBUSTIBLE SIDE WALL DISTANCE ENTRE COMPOSANTS COMBUSTIBLES, CÔTÉ AFSTAND TIL BRÆNDBART, MØBLERING ABSTAND VORNE ZU BRENNBAREN MÖBELN DISTANCE TO FURNITURE AT THE FRONT DISTANCE ENTRE COMPOSANTS COMBUSTIBLES, DEVANT	DK: 300mm SE BRUGERVEJLEDNING DE: 300mm SIEHE BEDIENUNGSANLEITUNG UK: 300mm SEE USER MANUAL FR: 300mm CONSULTEZ LE GUIDE DE L'UTILISATEUR DK:400 mm/SE BRUGERVEJLEDNING DE:400 mm/SIEHE BEDIENUNGSANLEITUNG UK:400 mm/SEE USER MANUAL FR:400 mm/CONSULTEZ LE GUIDE DE L'UTILISATEUR DK:1200 mm/SE BRUGERVEJLEDNING DE:1200 mm/SIEHE BEDIENUNGSANLEITUNG UK:1200 mm/SEE USER MANUAL FR:1200 mm/CONSULTEZ LE GUIDE DE L'UTILISATEUR
CO EMISSION CO EMISSION IN DEN VERBRENNUNGSPRODUKTEN EMISSION OF CO IN COMBUSTION PRODUCTS EMISSION CO DANS LES PRODUITS COMBUSTIBLES	DK: 0,079% DE: 0,079% / 989 mg/Nm³ UK: 0,079% FR: 0,079%
STØV / STAUB / DUST / POUSSIÈRES:	DK: 14 mg/Nm³ / DE: 14 mg/Nm³ UK: 14 mg/Nm³ / FR: 14 mg/Nm³
RØGGASTEMPERATUR / ABGASTEMPERATUR / FLUE GAS TEMPERATURE / TEMPÉRATURE DES GAZ DE FUMÉE:	DK: 263°C / DE: 263°C UK: 263°C / FR: 263°C
NOMINEL EFFEKT / HEIZLEISTUNG / THERMAL OUTPUT / PUISSANCE CALORIFIQUE:	DK: 6,5 kW / DE: 6,5 kW UK: 6,5 kW / FR: 6,5 kW
VIRKNINGSGRAD / ENERGIEEFFIZIENZ / ENERGY EFFICIENCY / EFFICACITÉ ÉNERGÉTIQUE:	DK: 81% / DE: 81% UK: 81% / FR: 81%
DK: Brug kun anbefalede brændstoffer. Følg instrukserne i brugermanualen. Anordningen er egnet til røggassamleledning og intervalfyring.	DK: BRÆNDE
DE: Lesen und befolgen Sie die Bedienungsanleitung. Zeitbrandfeuerstätte. Nur empfohlene Brennstoffe einsetzen.	DE: HOLZ
UK: Fuel types (only recommended). Follow the installation and operating instruction manual. Intermittent operation.	UK: WOOD
F: Veuillez lire et observer les instructions du mode d'emploi. Foyer à durée de combustion limitée, homologué pour cheminée à connexions multiples. Utiliser seulement les combustibles recommandés.	FR: BOIS
Hergestell für /Produced for: ATTIKA FEUER AG, Brunnmatt 16, CH-6330 Cham / RAIS A/S, Industrivej 20, DK-9900 Frederikshavn	
	15a B-VG

Information plate



Produced at:

RAIS A/S, Industrivej 20, 9900 Frederikshavn, Danmark

EN 13240:2001+A2:2004

17

Raumheizer für feste Brennstoffe
Appliance fired by wood
Poêle pour combustibles solides

EC.NO: 838

Q-Tee II with reflector plate / Q-Tee II C with reflector plate

AFSTAND TIL BRÆNDBART, BAGVÆG
ABSTAND ZU BRENNBAREN BAUTEILEN, HINTEN
DISTANCE TO COMBUSTIBLE BACK WALL
DIST. ENTRE COMPOSANTS COMBUSTIBLES, ARRIÈRE
AFSTAND TIL BRÆNDBART, SIDEVÆG
ABSTAND ZU BRENNBAREN BAUTEILEN, SEITE
DISTANCE TO COMBUSTIBLE SIDE WALL
DISTANCE ENTRE COMPOSANTS COMBUSTIBLES, COTÉ
AFSTAND TIL BRÆNDBART, MØBLERING
ABSTAND VORNE ZU BRENNBAREN MÖBELN
DISTANCE TO FURNITURE AT THE FRONT
DISTANCE ENTRE COMPOSANTS COMBUSTIBLES, DEVANT

DK:200 mm/SE BRUGERVEJLEDNING
DE:200 mm/SIEHE BEDIENUNGSANLEITUNG
UK:200 mm/SEE USER MANUAL
FR:200 mm/CONSULTEZ LE GUIDE DE L'UTILISATEUR
DK:400 mm/SE BRUGERVEJLEDNING
DE:400 mm/SIEHE BEDIENUNGSANLEITUNG
UK:400 mm/SEE USER MANUAL
FR:400 mm/CONSULTEZ LE GUIDE DE L'UTILISATEUR
DK:1200 mm/SE BRUGERVEJLEDNING
DE:1200 mm/SIEHE BEDIENUNGSANLEITUNG
UK:1200 mm/SEE USER MANUAL
FR:1200 mm/CONSULTEZ LE GUIDE DE L'UTILISATEUR

CO EMISSION
CO EMISSION IN DEN VERBRENNUNGSPRODUKTEN
EMISSION OF CO IN COMBUSTION PRODUCTS
EMISSION CO DANS LES PRODUITS COMBUSTIBLES

DK: 0,0791%
DE: 0,0791% / 989 mg/Nm³
UK: 0,0791%
FR: 0,0791%

STØV / STAUB /
DUST / POUSSIÈRES:

DK: 14 mg/Nm³ / DE: 14 mg/Nm³
UK: 14 mg/Nm³ / FR: 14 mg/Nm³

RØGGASTEMPERATUR / ABGASTEMPERATUR /
FLUE GAS TEMPERATURE / TEMPÉRATURE DES GAZ DE FUMÉE:

DK: 263°C / DE: 263°C
UK: 263°C / FR: 263°C

NOMINEL EFFEKT / HEIZLEISTUNG /
THERMAL OUTPUT / PUISSANCE CALORIFIQUE:

DK: 6,5 kW / DE: 6,5 kW
UK: 6,5 kW / FR: 6,5 kW

VIKRNINGSGRAD / ENERGIEEFFIZIENZ /
ENERGY EFFICIENCY / EFFICACITÉ ÉNERGÉTIQUE:

DK: 81% / DE: 81%
UK: 81% / FR: 81%

DK: Brug kun anbefalede brændsler. Følg instrukserne i brugermanualen.
Anordningen er egnet til røggassamledning og intervalfyring.

DK: BRÆNDE

DE: Lesen und befolgen Sie die Bedienungsanleitung.
Zeitbrandfeuerstätte. Nur empfohlene Brennstoffe einsetzen.

DE: HOLZ

UK: Fuel types (only recommended). Follow the installation and
operating instruction manual. Intermittent operation.

UK: WOOD

F: Veuillez lire et observer les instructions du mode d'emploi.
Foyer à durée de combustion limitée, homologué pour cheminée à
connexions multiples. Utiliser seulement les combustibles recommandés.

FR: BOIS

Herstelt für / Produced for:

ATTIKA FEUER AG, Brunnmatt 16, CH-6330 Cham / RAIS A/S, Industrivej 20, DK-9900 Frederikshavn

15a B-VG
VKF-NR:
XXXXX

INSTALLATION

The following section explains how to install the wood stove and includes information about the packaging, installation distances etc.

DELIVERY PACKAGING

Upon delivery, the stove is secured to a transport pallet using four transport safety fittings, one in each corner (A).

The safety fittings are secured with screws, which must be unscrewed. The safety fittings can then be removed (B).

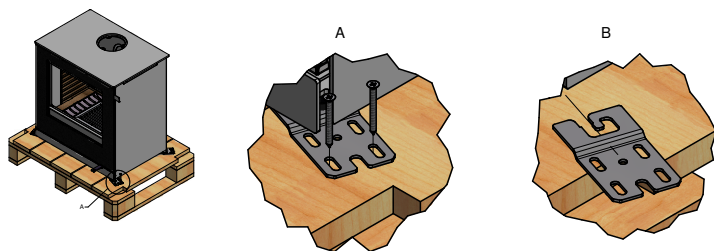

The top of the wood-burning stove has two polystyrene blocks (1), which protect the combustion chamber lining in transit. These must be removed before starting a fire in the stove.

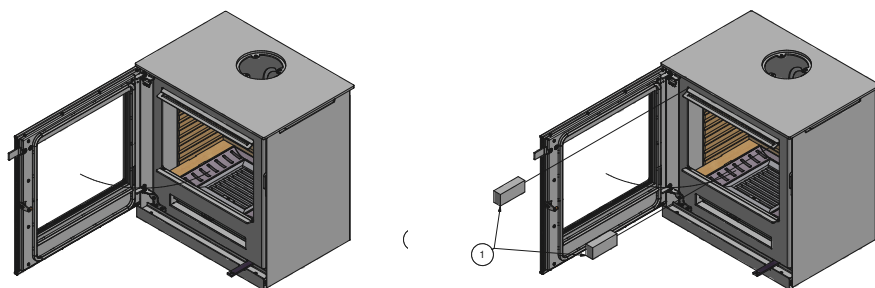

DISPOSAL OF PACKAGING

RECYCLING

The fireplace insert is delivered in recyclable packaging. This packaging must be disposed of in accordance with national regulations relating to the disposal of waste.

The glass is not recyclable.

The glass must be disposed of along with any residual ceramic or porcelain waste. Heat-resistant glass has a higher melting point, which is why it is not recyclable.

By ensuring heat-resistant glass does not end up alongside recyclable products you are making an important contribution to the environment.

Installation instructions

The following pages give instructions for the safe and proper installation of this heating appliance in the UK. These instructions cover the basic principles of installation, although detail may need slight modification to suit particular local site conditions. In all cases the installation must comply with current UK Building Regulations, Local Authority Byelaws and other specifications or regulations as they affect the installation of the stove. Please note that it is a legal requirement under England and Wales Building Regulations that the installation of the stove is either carried out under Local Authority Building Control approval or is installed by a Competent Person registered with a Government approved Competent Persons Scheme. HETAS Ltd operate such a Scheme and a listing of their Registered Competent Persons can be found on their website at www.hetas.co.uk.

It should be noted that the current Building Regulations requirements are given in Approved Document J. These requirements may also be met by adopting the relevant recommendations given in British Standards BS 8303 and BS EN 15287-1.

WARNING: Health and Safety Advice Notice

The installation of this heating appliance is governed by the Health and Safety at Work Act 1974. It is the responsibility of the installer to ensure that all requirements of this Act are met during the installation works. Attention is drawn in particular to the following:

Handling

The appliance is a heavy item and adequate facilities must be available for loading, unloading and site handling.

Fire Cement

Some types of fire cement are caustic and should not be allowed to come into contact with the skin. Protective gloves should be worn when handling fire cement. In case of contact with the skin wash immediately with plenty of water.

Asbestos

This stove contains no asbestos. If there is a possibility of disturbing any asbestos in the course of installation then please seek specialist guidance and use appropriate protective equipment.

Metal Parts

When installing or servicing this stove care should be taken to avoid the possibility of personal injury.

Important Warning –Preparatory Work and Safety Checks:

This stove must not be installed into a chimney that serves any other heating appliance. It's recommended not have an extractor fan fitted in the same room as the stove as this can cause the stove to emit fumes into the room.

If this appliance is installed into an existing chimney, the chimney must first be swept and examined for soundness and suitability before the appliance is installed (see also section headed "Chimney").

Chimney

The chimney is the driving force which makes the stove function. In order for the stove to perform satisfactorily the chimney height must be sufficient to ensure the correct draught of 12 to 18 Pa so as to clear the products of combustion and prevent problems of smoke emanating into the room when firing.

NOTE: A chimney height of not less than 4.5 metres measured vertically from the outlet of the stove to the top of the chimney should be satisfactory. Alternatively the calculation procedure given in BS 5854:1980 may be used as the basis for deciding whether a particular chimney design will provide sufficient draught.

The outlet from the chimney should be above the roof of the building in accordance with the provisions of Building Regulations Approved Document J.

If installation is into an existing chimney then it must be sound and have no cracks or other faults which might allow fumes into the house. Older properties, especially, may have chimney faults or the cross section may be too large i.e. more than 230 mm x 230 mm. Remedial action should be taken, if required, seeking expert advice, if necessary. If it is found necessary to line the chimney then a flue liner suitable for solid fuel must be used in accordance with Building Regulations Approved Document J.

Any existing chimney must be clear of obstruction and have been swept clean immediately before installation of the stove. If the stove is fitted in place of an open fire then the chimney should be swept one month after installation to clear any soot falls which may have occurred due to the difference in combustion between the stove and the open fire.

If there is no existing chimney then either a prefabricated block chimney in accordance with Building Regulations Approved Document J or a twin walled insulated stainless steel flue to BS 1856-1 can be used. These chimneys must be fitted in accordance with the manufacturer's instructions and Building Regulations.

A single wall metal fluepipe is suitable for connecting the stove to the chimney but is not suitable for using for the complete chimney. The chimney and connecting fluepipe must have a minimum diameter of 125 mm. Any bend in the chimney or connecting fluepipe should not exceed 45°. 90°bends should not be used.

Combustible material should not be located where the heat dissipating through the walls of fireplaces or flues could ignite it. Therefore when installing the stove in the presence of combustible materials due account must be taken of the guidance on the separation of combustible material given in Building Regulations Approved Document J and also in these stove instructions.

If it is found that there is excessive draught in the chimney then either an adjustable flue damper or alternatively a draught stabiliser should be fitted. The adjustable flue damper should not close off the flue entirely but should in its closed position leave a minimum continuous opening free area of at least 20 % of the total cross sectional area of the flue or fluepipe.

Adequate provision e.g. easily accessible soot door or doors must be provided for sweeping the chimney and connecting fluepipe.

The flue outlet spigot is either 150 mm (6") in diameter, or 129 mm (5") in diameter.

For strong draughts, the chimney or flue should be fitted with a draught stabiliser. In which case, it is important to ensure that there is a free flow-through area of minimum 20 cm² when the regulating gate is shut. Otherwise, the fuel energy may not be used optimally. If, at any time, you are unsure about the condition of the chimney, you should contact a chimney sweep.

Remember that access to the access door should be kept clear.

Installation

The stove is a free standing stove and it must be placed on a constructional hearth of at least 125mm in thickness unless the stove is elevated minimum 100mm above the hearth with a socket or legs.

Stoves that have been elevated a minimum of 100mm, can be placed on a superimposed hearth of non-combustible material at least 12 mm thick, in accordance with UK Building Regulations Approved Document J.

When installing the wood burning stove, there are some rules which **MUST** be followed:

When installing the appliance, all local rules and regulations, including those referring to national and European standards need to be complied with.

Local authorities and a chimney specialist should be contacted prior to set up.

It is prohibited to carry out unauthorised alterations to the stove.

There must be plenty of fresh air in the room where the stove is being installed, in order to ensure proper combustion - possibly through an airbox connection. Note that any mechanical exhaust ventilation - e.g. an extraction hood - may reduce the air supply. Any air grates must be placed in such a manner, that the air supply is not blocked.

The floor structure must be able to carry the weight of the wood burning stove, as well as the weight of a chimney, if necessary. If the existing floor construction doesn't meet this requirement, suitable measures (e.g. load distributing plate) shall be taken to achieve it. RAIS recommends to consult a building expert.

When you choose where to set up your RAIS wood burning stove, you should consider the heat distribution to the other rooms. This will enable you to get the best use out of your stove. The stove should be set up at a safe distance from inflammable materials.

See the manufacturer's plate on the wood burning stove.

Upon receiving the stove must be inspected for defects.

Freestanding installation distance in case of combustible wall

To determine whether the wall next to where the stove is going to be installed is flammable, you should contact your building contractor or the local building authorities.

The hearth should be able to accommodate the weight of the stove. The chimney must be independently supported by wall brackets or a ceiling support plate. The weight of the stove is indicated in the brochure.

If the Q-Tee 2 is installed with the RAIS/attika log store, the distance in front of the stove must meet the UK Building Regulations of 300mm.

Recess Installation - non combustible walls

For installation within a non combustible recess (ie a typical UK chimney breast), please refer to Section J of the UK Building Regulations which advise a minimum 225 or 300mm in front of the appliance.

The clearance distances to combustible material beneath, surrounding or upon the hearth and walls adjacent to the hearth should comply with the guidance on the separation of combustible material given in UK Building Regulations Approved Document J and also in these stove instructions.

It must be ensured that no combustible objects (eg. furniture) are placed closer than the distances given in the following tables (risk of fire).

IMPORTANT:

Please bear in mind that the installation distances on the following pages only apply to the wood-burning stove. The final choice of Chimney solution may have a larger safety distance to the flammable material. The Chimney solution must always be installed in accordance with current building regulations and in a manner that ensures CE-marking compliance.

INSTALLATION DISTANCE TO FLAMMABLE MATERIAL:

The installation distances applicable to the wood-burning stove are shown below. Bear in mind that the final choice of chimney may have a different safety distance. All dimensions are in mm.

Uninsulated flue

Right-angle installation

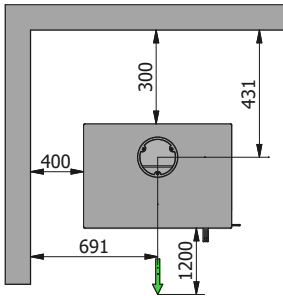

Corner installation

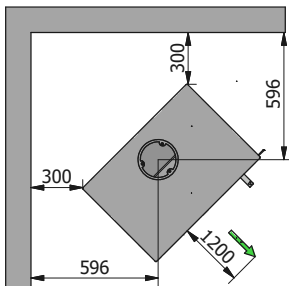

Flammable ceiling

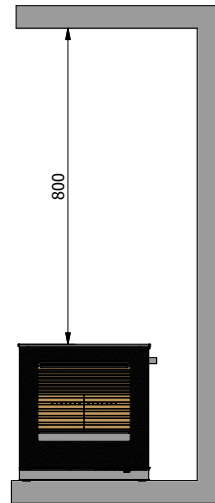

Safety distances to the flammable ceiling are measured from above the door.

INSTALLATION DISTANCE TO FLAMMABLE MATERIAL:

The installation distances applicable to the wood-burning stove are shown below. Bear in mind that the final choice of chimney may have a different safety distance. All dimensions are in mm.

Insulated flue

Right-angle installation

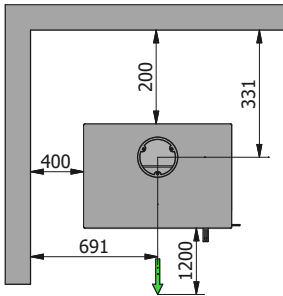

Corner installation

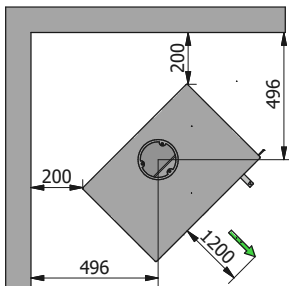

Flammable ceiling

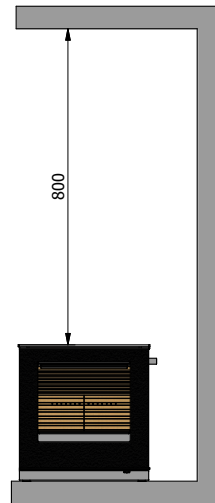

Safety distances to the flammable ceiling are measured from above the door.

INSTALLATION DISTANCE TO FLAMMABLE MATERIAL:

The installation distances applicable to the wood-burning stove are shown below. Bear in mind that the final choice of chimney may have a different safety distance. All dimensions are in mm.

Uninsulated flue

Right-angle installation

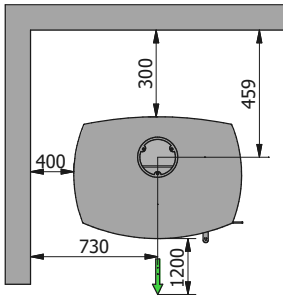

Corner installation

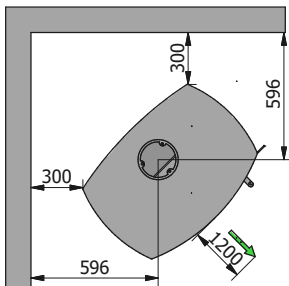

Flammable ceiling

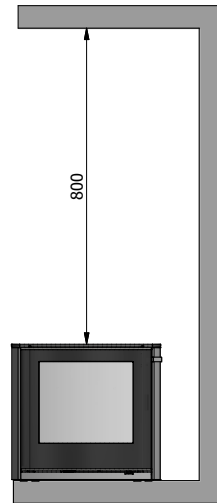

Safety distances to the flammable ceiling are measured from above the door.

INSTALLATION DISTANCE TO FLAMMABLE MATERIAL:

The installation distances applicable to the wood-burning stove are shown below. Bear in mind that the final choice of chimney may have a different safety distance. All dimensions are in mm.

Insulated flue

Right-angle installation

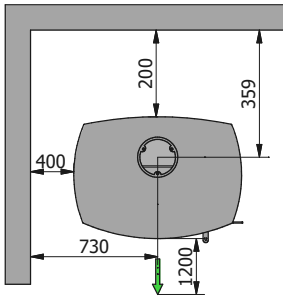

Corner installation

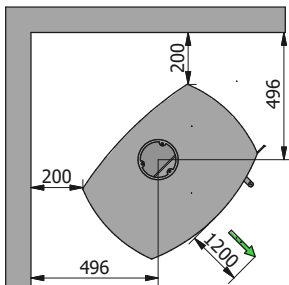

Flammable ceiling

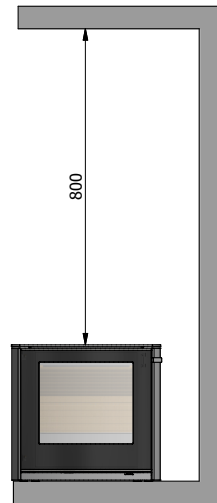

Safety distances to the flammable ceiling are measured from above the door.

HEIGHT ADJUSTMENT

The stove is equipped with four adjustment screws (1) under the stove.
Use the adjustment screws to ensure the wood-burning stove stands level.

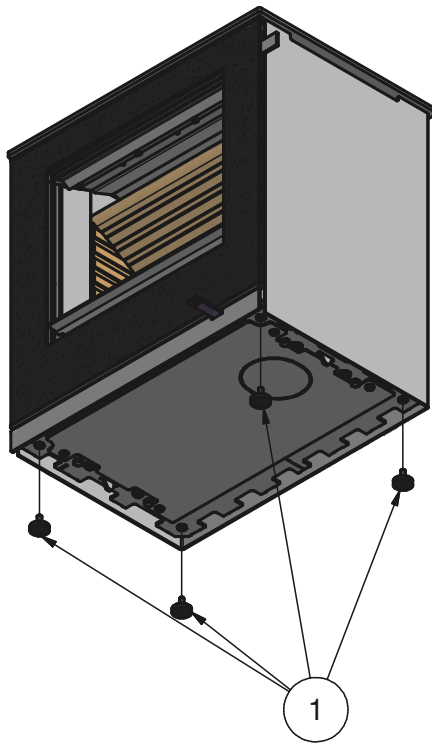

FITTING/CHANGING THE HANDLE

The wood-burning stove comes with a temporary handle (1). To remove it, undo the nuts (2). The new handle (3) can now be fitted to the stove using the nuts (2).

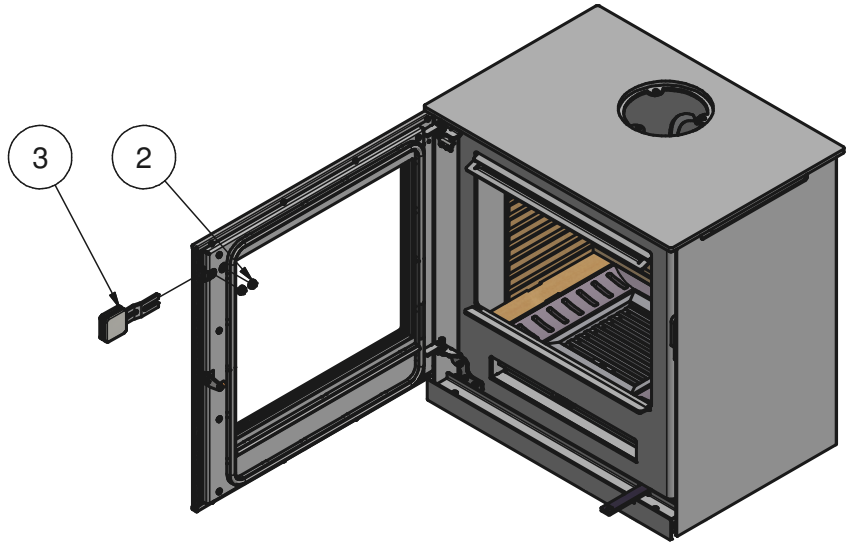
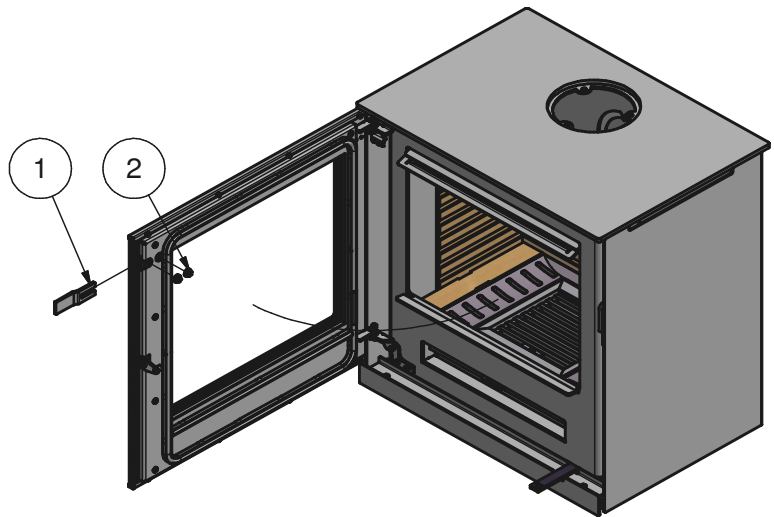
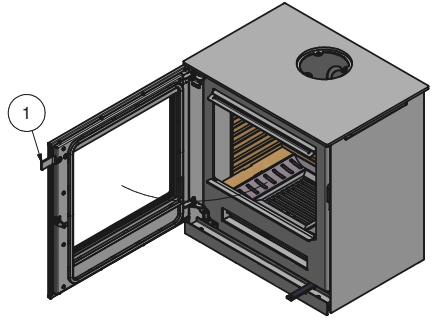

GB

REMOVING THE COMBUSTION CHAMBER LINING

The combustion chamber lining protects the body of the fireplace insert from the heat of the fire. The large differences in temperature can lead to cracks in the combustion chamber lining. This will not affect the functionality of the fireplace insert. The lining will only need to be replaced after several years of use when it begins to disintegrate. The liner panels are easy to place in position in the fireplace insert and can easily be replaced by you or your dealer.

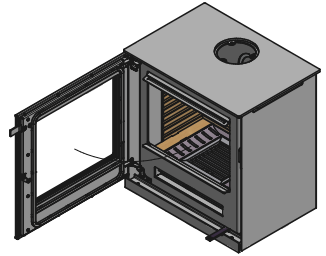

Procedure for removing the combustion chamber lining:

Remove the smoke deflector plate (1) by pulling it forward and tilting it so that it is free of the vertical plates. The smoke deflector can now be carefully removed.

2. Remove the base plates (2).

3. Loosen the side plates (3) by turning the front end of the plate towards the center of the stove. Then take them out carefully.

4. Remove the back plates (4) by pulling the side of the plates forward and out.

When the combustion chamber liner is to be reassembled, do so in reverse order.

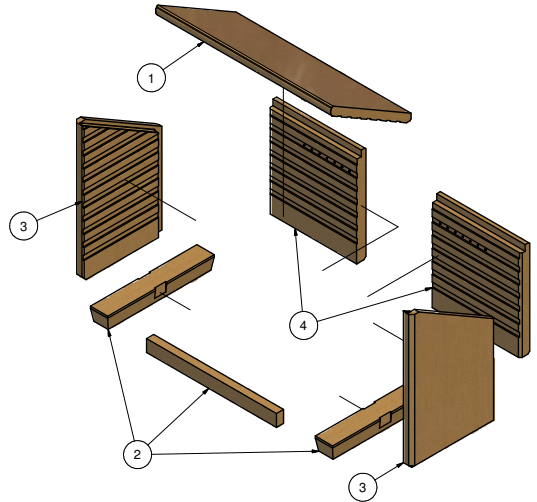

MAX LOAD

The maximum allowable amount of firewood is marked with a series of holes in the back plates. This means that firewood may only be filled up to this row of holes.

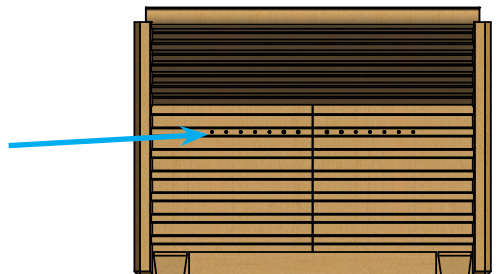

LUBRICATING THE HINGES

LUBRICATING THE HINGES & LOCK

The fireplace must be lubricated regularly using the three moving parts on the lock and hinges (see image). Use heat-resistant oil.

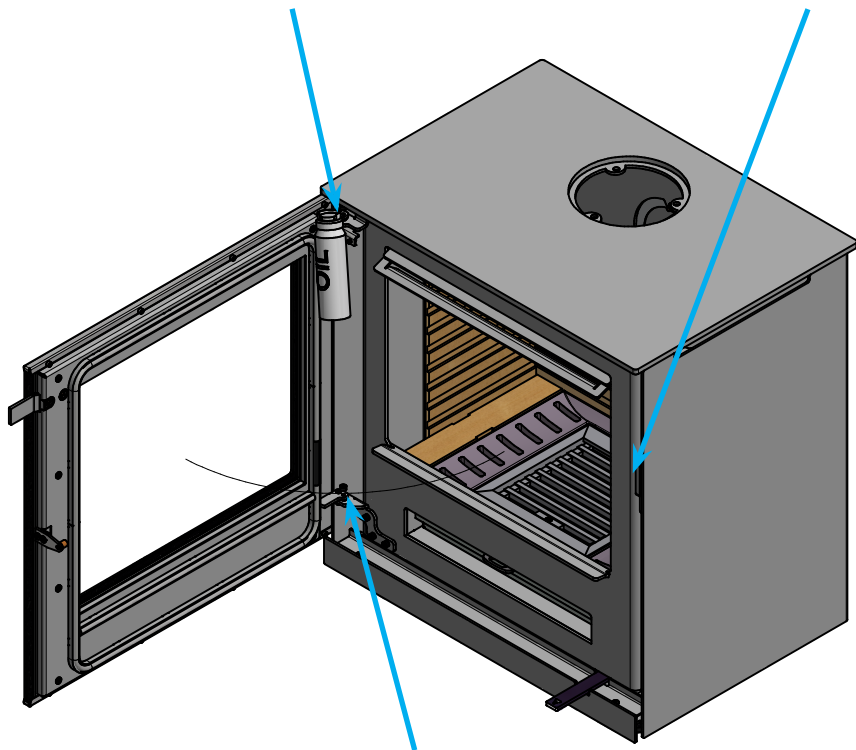

Smoke outlet to rear outlet

INSTALLATION OF SMOKE OUTLET FOR REAR OUTLET.

The stove is ready for top exit on delivery, but can be changed to rear exit in the following way.

1. On the back of the stove there is a knock-out form that must be knocked free of the back. It is attached via four small pins.
2. Remove the knock-out form with a hammer or similar.
3. Remove the cover (1) and gasket (2) from the rear outlet and mount it on the top outlet.
4. Mount the smoke connection (3) on the rear exit.

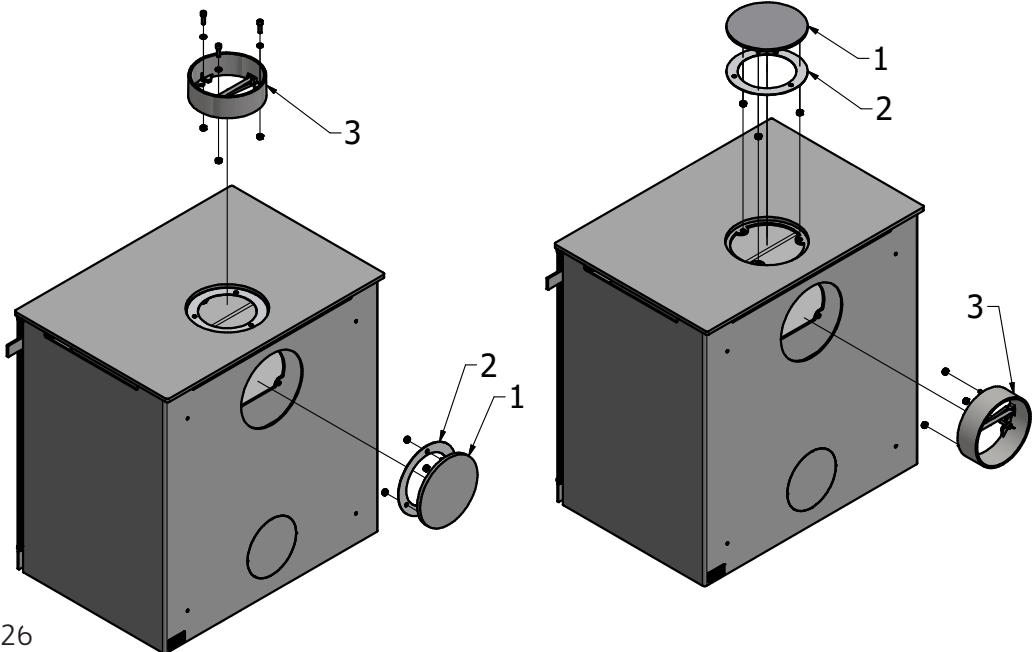
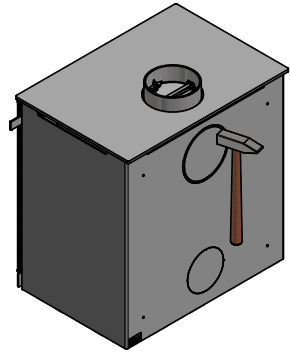



TEST Reg.nr. 300

**TEKNOLOGISK
INSTITUT**Teknologiparken
Kongsvang Allé 29
DK-8000 Aarhus C
Phone +45 72 20 10 00
Fax +45 72 20 10 19
Info@teknologisk.dk**TEKNOLOGISK INSTITUT**Akkrediteret prøvningsorgan, DANAK-akkreditering nr. 300
Notificeret prøvningsorgan med ID-nr. 1235**Prøvningsattest II****Uddrag af rapport nr. 300-ELAB-1882-EN og 300-ELAB-1882-NS og****bedømmelse dateret 18/5-2017****Emne:** Brændeovn: Rais Q-Tee II og Rais Q-Tee II C**Rekvirent:** Rais A/S
Industrivej 20, 9900 Frederikshavn
CVR nr.: 25195612 P-nr.: 1001580195

Procedure:	<input checked="" type="checkbox"/>	Prøvning efter DS/EN13240/A2:2004
	<input checked="" type="checkbox"/>	Prøvning efter NS3058-1 & -2 (partikelmåling)
	<input checked="" type="checkbox"/>	Emissionsmåling efter CEN/TS 15883 (støv og OGC)

Prøvningsresultater

Akkrediteret prøvning af brændeovn iht. EN 13240 er foretaget med brænde der påfyres manuelt, og følgende resultater blev opnået:

Nominal ydelse:	5,6	kW
CO-emission:	0,08	% - henført til 13 % O ₂
Virkningsgrad:	81	%
Røggastemperatur:	263	°C
Afstand til bagvæg:	-	se vejledning
Afstand til sidevæg:	-	se vejledning

Emissioner iht. NS 3058 og/eller CEN/TS 15883:

Partikler efter NS 3058:	1,87	g/kg (tørstof) middelværdi (krav 2015:5 / 2018:4)
Partikler efter NS 3058:	2,22	g/kg (tørstof) maksimalt (krav 2015:10 / 2018:8)
OGC efter CEN/TS 15883:	63	mgC/Nm ³ ved 13% O ₂ (krav 2015:150 / 2018:120)
Støv efter CEN/TS 15883:	14	mg/Nm ³ ved 13% O ₂ (krav 2015:40 / 2018:30)

Bemærk venligst, at de oplyste værdier er et uddrag af prøvningsrapporten.
For yderligere oplysninger henvises til prøvningsrapporten, se nummer ovenfor.

Aarhus, den 18. maj 2017  Kim Sig Andersen Konsulent	Skorstensfejerpåtegning
--	-------------------------

På baggrund af ovennævnte emissioner attesteres det hermed, at fyringsanlægget opfylder emissionskravene i bilag 1 til Bekendtgørelse nr. 46 af 22/01-2015 om regulering af luftforurening fra fyringsanlæg til fast brændsel under 1 MW, for så vidt:

Krav indtil januar 2018 opfyldt:	<input checked="" type="checkbox"/>	Krav efter januar 2018 opfyldt:	<input checked="" type="checkbox"/>
----------------------------------	-------------------------------------	---------------------------------	-------------------------------------



RAIS A/S
Industrivej 20
DK-9900 Frederikshavn
Denmark
www.rais.dk



ATTIKA FEUER AG
Brunnmatt 16
CH-6330 Cham
Switzerland
www.attika.ch