



VISIO UNIQ 3:1

USER MANUAL (UK)

PRODUCTION NUMBER

PRODUCTION NUMBER

Congratulations on your stove. Each stove has its own unique production number. The production number is located in the oven's bottom left corner, but it is included as well on the first page of the printed user manual. The number is the stove's identification and must be used in any enquiries related to the stove's warranty.

In order to ensure you have all the information needed in case you have any questions, please write down the production number, where you bought the stove and when you did so.

Date: _____

Dealer: _____

Production number: _____

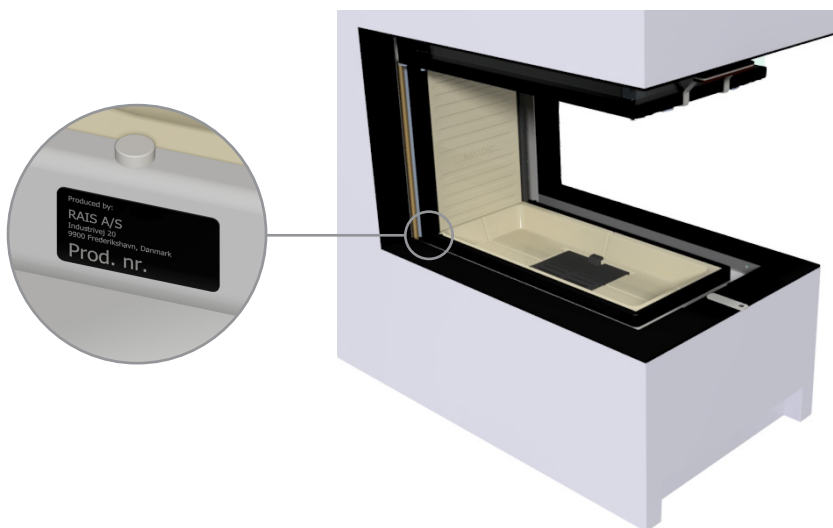

CONTENT

CONGRATULATIONS ON THE PURCHASE OF YOUR NEW STOVE	5
WOOD	6
use approved fuels only	6
The wood must be dry	6
Your wood must fit the stove	7
FIRING	8
Recommended amount of wood for stoking the fire	8
Time interval for refuelling	9
SETTING THE DAMPER	10
Air damper adjustment	10
LIGHTING YOUR STOVE CORRECTLY	11
Lighting your stove for the first time	11
Ignition and refuelling	12
Overfiring	15
CLEANING YOUR STOVE	16
Cleaning the outside of your stove	16
Cleaning of combustion chamber	17
Cleaning the glass	18
Opening the glass for cleaning	18
REMOVING THE COMBUSTION CHAMBER FOR LINING	20
CLEANING THE FLUE	21
MAINTAINING YOUR STOVE	22
Checking the chimney	22
Moving parts	22
Replacing seals	22
FURNISHING DISTANCE	23

CONTENT

GENERAL INFORMATION ON TOUR STOVE	24
Convection	24
Glass system	24
External air supply - Airsystem	24
CO ₂ and the enviroment	24
FREQUENTLY ASKED QUESTIONS – FAQ	25
Why is my stove not burning the way it should?	25
Why is my stove making "clicking noises"?	25
Why does the glass turn black?	25
Why is smoke coming out of the door?	26
Why is my stove giving off an odour?	26
Why is my stove getting too hot?	26
Why is my stove covered in soot on the outside, above the door?	26
Why is my stove burning too firecely?	26
Why is my stove not burning sufficiently?	27
What can i do if my chimney is not drawing properly?	27
I am encountering other difficulties with my stove	27
GUARANTEE	28
RECYCLING	29
SPECIFICATIONS	30

EN



CONGRATULATIONS ON THE PURCHASE OF YOUR NEW STOVE

Congratulations on the purchase of your new wood-burning stove – and welcome to RAIS or attika! High quality, design and function go hand in hand in the wood-burning stove you have selected.

For the latest tips, information and inspiration, follow us on our various channels:



We have put our hearts, souls and minds into each and every one of our products. We want you to enjoy using your stove for many years to come, so we have focused all our efforts on ensuring that this is possible.

You are now about to learn all about your stove – and turn your dream into reality. You will soon be enjoying using the stove in your home.

This user guide can help you get started with your new wood-burning stove. You will receive an in-depth introduction to the following topics below:

- Wood
- Setting the damper and lighting your stove correctly
- Cleaning and maintaining your stove
- Frequently asked questions – FAQ

It is important for you to read up on all these topics so that you can get the maximum out of your wood-burning stove. You can also return to the user guide if you have any problems or queries when you have been using your stove for a while. We hope you will find all the information that you need.

You can get in touch with your RAIS/attika dealer if you have any further questions.

Always make sure to comply with all local regulations, including those referring to national and European standards when operated.

Enjoy using your new stove!

It is important for you to use dry, untreated wood and light the wood correctly so that your wood-burning stove can operate correctly. Which wood you should use and how to treat it prior to use are shown below.

USE APPROVED FUELS ONLY

General wood (wood that you have purchased or collected yourself) or pure wood briquettes are approved fuels. You should not use newspaper or similar as this will cause soot in your stove and give off contaminated smoke.



WARNING

Never use lacquered, laminated or impregnated wood, wood with a plastic coating, painted wood, chipboard, plywood, household waste, paper briquettes or coal. This may cause toxic smoke that smells unpleasant and causes contamination. Under no circumstances use any form of liquid fuel as this could cause an explosion. Your guarantee will be rendered void if you burn non-recommended fuel in your stove and cause it to overheat.

THE WOOD MUST BE DRY

If you can, bring in the wood a couple of days before you want to use it so that it is at room temperature. The wood must have a water content of 15-20%. In practice, this means your wood should be left to dry for at least one year (and ideally two) before you use it. As a result, it is a good idea to buy your wood early and organise good storage for it. Wood needs time to dry, and proper air drying can take up to 2 years depending on the type of wood and how it is stored.

Wood dries best when it is sawn and chopped. Place your wood in a well ventilated, sunny location protected from the elements, ideally under a lean-to or a woodshed, i.e. a shed with slatted sides. Avoid covering your wood, this will retain the moisture. Drying wood outdoors is almost always best because this ensures that plenty of air can circulate.



YOUR WOOD MUST FIT THE STOVE

The pieces of wood you use must fit the combustion chamber of your stove. Pieces of wood of a diameter greater than 10 cm should be chopped.



WARNING

If you use incorrect wood or wood that is too damp, this may cause soot to form in the chimney, possibly leading to a chimney fire. If this happens, close off all air supplies to your stove if a valve connected to an AirSystem connection from outside is installed.

CALL THE FIRE SERVICE IF YOUR CHIMNEY CATCHES FIRE.

Never use water to put the fire out!

Then contact a chimney sweep to check your stove and chimney.



WARNING

Never use petrol, lamp oil, kerosene, charcoal lighter fluid, ethyl alcohol or similar liquids to start or "re-ignite" a fire in the heater. Keep all such liquids well away from the heater while it is in use.

RECOMMENDED AMOUNT OF WOOD FOR STOKING THE FIRE

To find the recommended amount of wood for stoking the fire, please refer to the tables below.

The recommended amount of wood to burn after lighting depends on your stove model. Based on the nominal output of your stove, you can read the recommended amount of wood to use for refuelling.

EXAMPLE OF READING THE RECOMMENDED FIRING RATE WHEN REFUELLING

By reading the CE labelling plate (or finding the output on our website), the stove has a nominal output of 11.3 kW. See an example of the CE labelling plate on the next page.

Based on the rated output, the recommended amount of wood to be used when refuelling the stove can be read from the wood quantity table for wood-burning stoves.

Recommended volume of wood for stoking fireplace inserts

Nominal output, kW (according to the CE marking plate)	Max kg. of wood per hour	Number of pieces of firewood
4 - 4,9	2	Max 3
5 - 5,9	2.5	Max 3
6 - 6,9	2.75	Max 3
7 - 7,9	3	Max 3
8 - 8,9	4	Max 4
9 - 9,9	4	Max 4
10 - 10,9	4.5	Max 4
11 - 12	4.5	Max 5

** The exact indication of the recommended volume of wood to be stoked (kg) is found in your fireplace insert's installation manual under "Specifications".

The table indicates that if the stove's output is between 11 and 12 kW, it is possible to use up to 4.5 kg of wood per hour, split into a maximum of 5 pieces of firewood (see table).

The stove will be considered to have overfired and the warranty will be voided if more than this is used.

23

EN 13240:2001+A1:2004,
EC.NO: 14
Notified Body: 1235



Produced at: RAIS A/S, Industrivej 20, 9900 Frederikshavn, Denmark

Visio Uniq 3:1

AFSTAND TIL BRÆNDBART, BAGVEG
ABSTAND ZU BRENNBAREN BAUTEILEN, HINTEN
DISTANCE TO COMBUSTIBLE BACK WALL
DIST. ENTRE COMPOSANTS COMBUSTIBLES, ARRIÈRE

AFSTAND TIL BRÆNDBART, SIDEVÆG
ABSTAND ZU BRENNBAREN BAUTEILEN, SEITE
DISTANCE TO COMBUSTIBLE SIDE WALL
DISTANCE ENTRE COMPOSANTS COMBUSTIBLES, CÔTÉ

AFSTAND TIL BRÆNDBART, MØBLERING
ABSTAND VORNE ZU BRENNBAREN MÖBELN
DISTANCE TO FURNITURE AT THE FRONT
DISTANCE ENTRE COMPOSANTS COMBUSTIBLES, DEVANT

CO EMISSION (REL. 13% O2)
CO EMISSION IN DEN VERBRENNINGSPRODUKTEN (BEI 13%O2)
EMISSION OF CO IN COMBUSTION PRODUCTS (AT 13%O2)
EMISSION CO DANS LES PRODUITS COMBUSTIBLES (À 13%O2)

STØV / STAUB / DUST / POUSSIÈRES:

RØGGASTEMPERATUR / ABGASTEMPERATUR / FLUE GAS TEMPERATURE /
TEMPÉRATURE DES GAZ DE FUMÉE:

NOMINEL EFFEKT / HEIZLEISTUNG / THERMAL OUTPUT / PUISSANCE
CALORIFIQUE:

DK: Brug kun anbefalede brændsler. Følg instrukserne i brugermanualen.
Anordningen er egnet til røggassamledning og intervalfyring.

DE: Lesen und befolgen Sie die Bedienungsanleitung.
Zeitbrandfeuerstätte. Nur empfohlene Brennstoffe einsetzen.

UK: Fuel types (only recommended). Follow the installation and
operating instruction manual. Intermittent operation.

FR: Veuillez lire et observer les instructions du mode d'emploi.
Foyer à durée de combustion limitée, homologué pour cheminée à connexions
multiples. Utiliser seulement les combustibles recommandés.

(Not to be used in a shared flue in UK)

Geeignet für den Anschluss an einen gemeinsamen Schornstein, sofern beide
Geräte den gleichen Besitzer haben.
Suitable for connection to a shared flue, on the condition that both devices have
the same owner.

DK: 0 mm SE BRUGERVEJLEDNING
DE: 0 mm SIEHE BEDIENUNGSANLEITUNG
UK: 0 mm SEE USER MANUAL
FR: 0 mm CONSULTEZ LE GUIDE DE L'UTILISATEUR

DK: 600 mm SE BRUGERVEJLEDNING
DE: 600 mm SIEHE BEDIENUNGSANLEITUNG
UK: 600 mm SEE USER MANUAL
FR: 600 mm CONSULTEZ LE GUIDE DE L'UTILISATEUR

DK: 800 mm SE BRUGERVEJLEDNING
DE: 800 mm SIEHE BEDIENUNGSANLEITUNG
UK: 800 mm SEE USER MANUAL
FR: 800 mm CONSULTEZ LE GUIDE DE L'UTILISATEUR

≤ 0,12 % / ≤ 1500 mg/Nm³

≤ 40 mg/Nm³

262 °C

11,3 kW

DK: BRÆNDE

DE: HOLZ

UK: WOOD

FR: BOIS

Raumheizer für feste Brennstoffe
Appliance fired by wood
Poêle pour combustibles solides

11,3 kW

Produced for: ATTIKA FEUER AG, Brunnmatt 16, CH-6330 Cham / RAIS A/S, Industrivej 20, DK-9900 Frederikshavn

TIME INTERVAL FOR REFUELLING

The recommended fuel quantity should be stoked within 45–60 minutes from the last stoking.

The exact interval for when to stake the volume of wood is 52 minutes which can be seen under "Specifications" in the stove's installation manual under "Intermittent operation".

SETTING THE DAMPER

It is worthwhile spending some time finding out how best to operate the damper on your stove. This will ensure your wood burns as effectively as possible and gives you the most beautiful fire.

AIR DAMPER ADJUSTMENT

The three settings on the damper are adjusted by rotating it from side to side.



POS 1 - STARTUP

POSITION 1. Push the damper all the way to the right. The air damper is fully open and provides full air when starting your stove. This position is solely for use when starting your stove (approx. 10-20 minutes) and topping up and is not used during normal operation.



POS 2 - IN OPERATION

POSITION 2. Push the handle to the left to the first “notch”. This is the central position. During regular burning, we recommend placing the damper between positions 2 and 3. When the damper is set correctly, the flames are clear and yellow.



POS 3 - CLOSED

POSITION 3. Push the handle all the way to the left. The air damper is closed, which keeps the air supply to a minimum. This setting should be avoided while your stove is operation, but it can be used when your stove is not in use.

Combustion in your stove will be poor if it is not getting enough air, and in a worst-case scenario this may result in fumes, smoke, inefficient use of the wood and less heat. A dark smoke will emerge out of the chimney. The smoke from the chimney is almost invisible if the wood is burning correctly.

REMEMBER!



If you find your stove is getting too hot you should not turn the damper down all the way – instead, you should vent the stove. You cannot adjust the heat in the room using the damper, only the amount of wood you use can affect this.

LIGHTING YOUR STOVE CORRECTLY

LIGHTING YOUR STOVE FOR THE FIRST TIME

When you use your stove for the first time, it is best to light a small fire initially so that it “gets used to” the high temperatures. There may be a little odour and smoke due to the materials used in the stove – but this will soon disappear and it will only occur the first couple of times you light your stove. Make sure you allow this smoke to escape. The first time you light your stove, it is also recommended that you should open and close the door at regular intervals to prevent the seal on the door sticking.

If your stove has been left unused over the summer, for example, light a small fire the first time you start using it again. Your stove may give off a slight odour the first time you light it after any length of time.

If you adjust the airflow manually, the damper on the stove is set to fully open when you light it, and you then close it slightly as the fire gets going. See the following section for how to light your stove correctly and adjust the air damper.

NOTE:

Remember to open and close the door slowly when adding wood. This will not cause overpressure in the chimney and cause smoke to emerge into the room.

REMEMBER!

When you use your stove for the first time, it is important for you to vent it while the paint settles (the stove gives off an odour and a small amount of smoke). This process may be repeated the first couple of times you use your stove. This will decline when your stove has reached its maximum temperature. Avoid touching the paint on your stove before lighting it for the first time and before the stove has cooled completely.



TESTING YOUR STOVE

You can test how your stove is burning by checking:

- Is the ash pale or white?
- Are the walls of the combustion chamber soot-free?
- Is the smoke from your chimney almost invisible?

If you answer “yes” to all three of these questions, your stove is burning well.



LIGHTING YOUR STOVE CORRECTLY

IGNITION AND REFUELLING - "Top-down" burning

Follow the instructions 1-5 below for correct ignition and use of the stove.



You should **never** open the door when the flames are high, as they can damage the paint on the stove.

- ① Begin by stacking 12 pieces of split firewood in layers of four at the bottom of the stove. Place the ignition bags between layers 2 and 3, as shown in the image. Place the remaining two sticks. The split firewood should measure about 4x3x23 cm. It is critical that there is air between the pieces; otherwise, the fire will struggle to take hold.

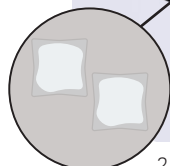
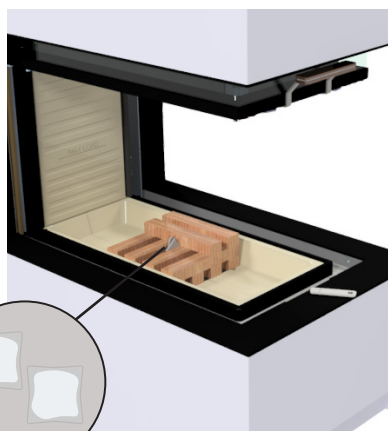

2 pcs ignition bags

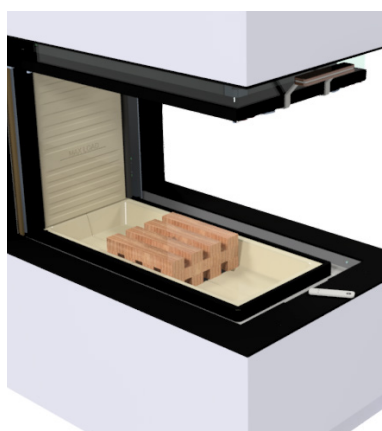

LIGHTING YOUR STOVE CORRECTLY

- ② Set the air damper to the open position. Light the fire by igniting the two ignition bags placed between the layers.

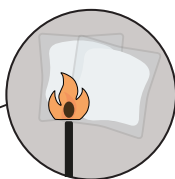

Igniting the ignition bags

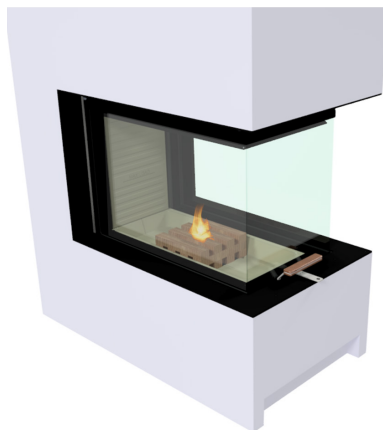

NOTE! - It is important to get the wood burning quickly.

- ③ When the fire has a firm grip on the sticks, set the air damper to the centre position.



If the fire has burned down too far and there is not enough embers, start the lighting process all over again.



LIGHTING YOUR STOVE CORRECTLY

- ④ When the last flames have died and there is a nice layer of embers, add two to three pieces of wood. Only add new wood after the smaller pieces have burned down to a reasonable level, not while the fire is in full flame.

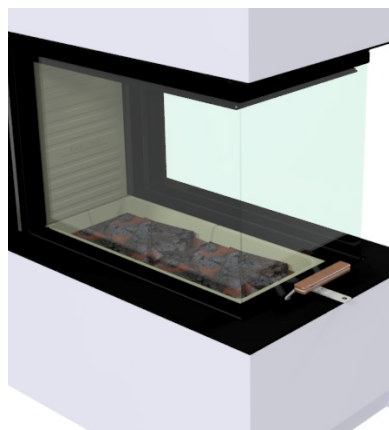

- ⑤ After 5 minutes - or when there are clear yellow flames - gradually close the damper.





WARNING

To ensure safe combustion, the flames must be clear and yellow or the embers must be clear – the wood must never sit and “smoulder”. If the fire is merely smouldering or smoking and insufficient air is supplied, this will cause uncombusted fumes to form. Fumes may ignite and explode. This may cause damage, and potentially injure people.

THEREFORE, NEVER CLOSE OFF THE AIR SUPPLY ENTIRELY WHEN LIGHTING YOUR STOVE.

OVERFIRING

The oven must not be overfired. The maximum firing quantity of your stove can be found in the table. If more than the specified amount of wood read in the table on page 8 is used, the stove is overfired.

If the wood quantity limits in the table are exceeded, the stove is considered overfired and is no longer covered by the factory warranty, as the stove may be destroyed by excessive heat.

CLEANING YOUR STOVE

When using your stove, it is important for you to know how to maintain it. This section describes how to clean and maintain your stove.

CLEANING THE OUTSIDE OF YOUR STOVE

When cleaning the outside of your stove, how you go about this is dependent on the colour of the stove and what it is made of. The table below shows how to clean your stove.

Note: Your stove must only be cleaned when cold.

It is important to clean your stove regularly. If dirt and stains are left on the stove (particularly in pale areas), there is a risk of the stains being burnt on.

If you need to maintain the surface, all colours are available as spray paints.

If general cleaning is not enough to remove any discolouration, please contact your RAIS/attika dealer.

Stove colour	Procedure
White Nickel Platinum Silver	Wipe with RAIS Brændovnsrens or warm, soapy water (washing-up liquid)
Black Mocha	No liquids. Wipe with a wrung-out cloth

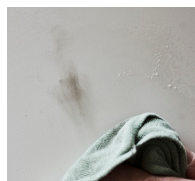

TIP! - We recommend that you always use regular, mild detergents for cleaning your stove. Always test a detergent in a non-visible location (behind the stove, for example) before cleaning.

CLEANING YOUR STOVE

CLEANING OF COMBUSTION CHAMBER

The combustion chamber is emptied of ash as needed. You can carefully take the ashes out with a small hand shovel, or sweep it through the grate into the ash tray. The ash must be completely cooled before it is discarded, as it can still store itself glows in it for up to two days. Open the grate to access the ash drawer, see picture below. Remember to use a glove when the oven is hot. Never completely empty cover the firebox with ash, as the fire burns best with a small layer of ash.

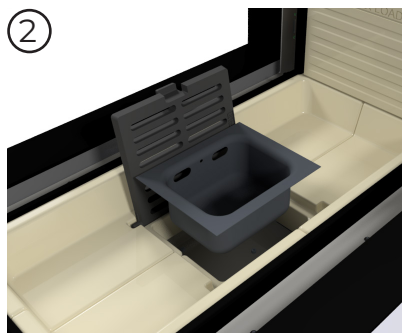

Scrape/shovel the ash into the grate in the centre of the fireplace insert. The ash drawer underneath the grate can be removed and emptied in a non-combustible container until it has cooled off. Ash can be disposed of as ordinary household waste.

GLASS

All RAIS and attika stoves come with a glass system, which means that hot air flows down over the glass and removes any soot residues. This happens when the fire is burning correctly and there is a high level of combustion in the stove. However, you may still find some soot on the glass when using your stove.

CLEANING THE GLASS

There are three effective ways of cleaning the glass on your stove:

1. Schott dry sponge. Available from most stove dealers.
2. Window cleaner suitable for stoves. Follow the instructions. When using detergent, you must always rinse with clean water so that any detergent residues are also removed. This will prevent residues burning onto the glass and leaving marks the next time your stove gets hot.
3. Cleaning with ash. Clean the inside of the glass with a damp cloth dipped in the very fine ash inside the stove. Then wipe down and polish with a soft cloth. Your stove must be cold when you start cleaning it.

OPENING THE GLASS FOR CLEANING

Before the side doors can be opened for cleaning, the door must be placed in bottom position. There are two locking hooks above the door. The hook on the right side is rotated to the right and the left hook to the left to release them.

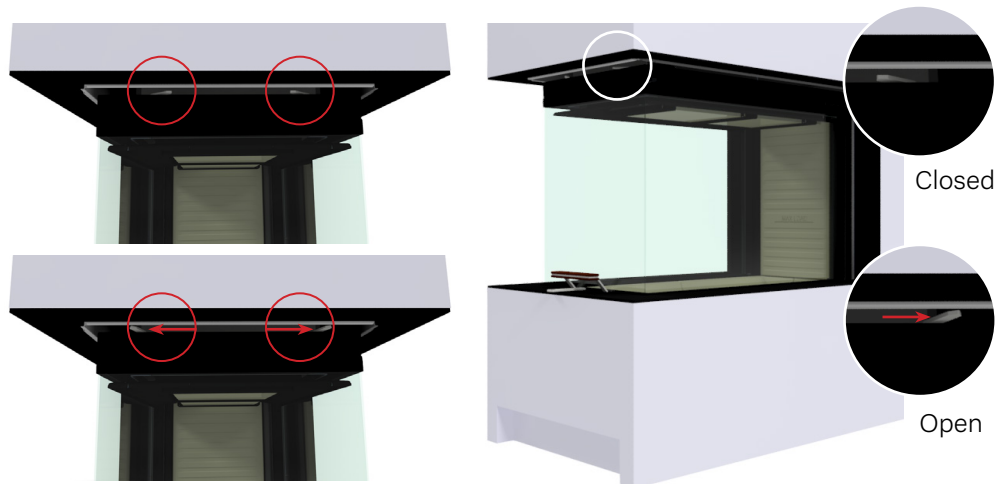

CLEANING YOUR STOVE

There is a door stop on both sides of the door. By turning them out, you ensure that the locking hooks cannot hit the built-in frame. Lift the door and twist out both door stops.

There are also locking hooks under the door, which are turned in the same way as the upper locking hooks. These can advantageously be opened at the same time. The door can now be lowered, and the door stops will land on their contact surface inside the stove.

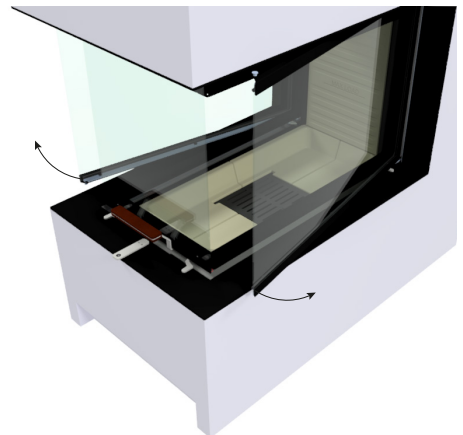
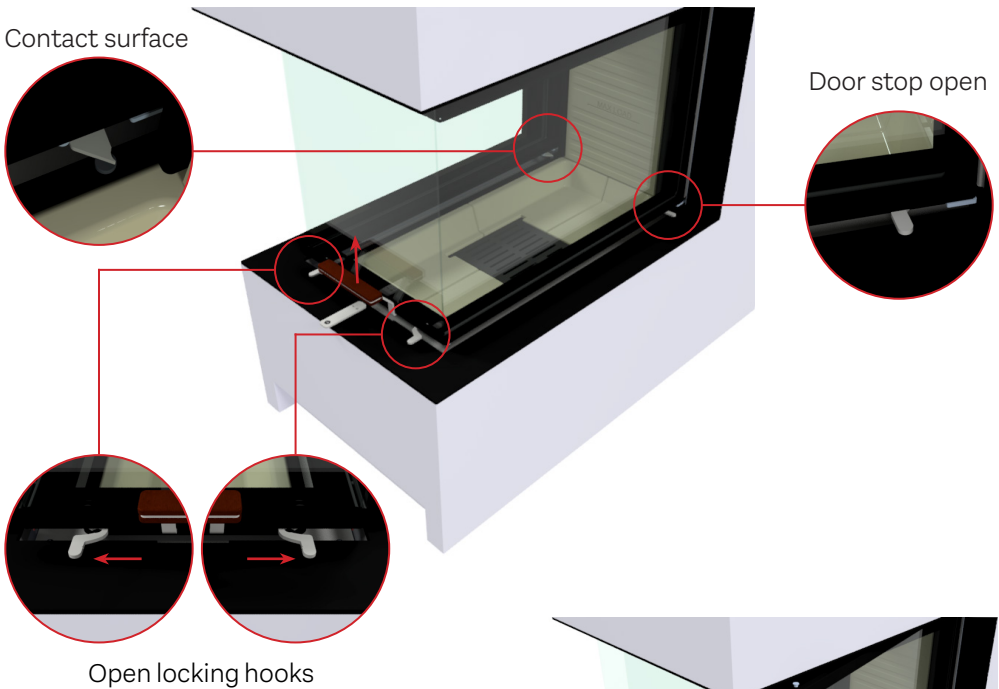

The side doors can now be opened for cleaning the door glasses. The side doors are locked again, in reverse order. Remember all 4 locking hooks and the two door stops.

REMOVING THE COMBUSTION CHAMBER LINING

The combustion chamber lining protects the fireplace insert against the heat from the fire. The large temperature fluctuations can cause cracks in the plates, which, however, do not affect the functionality of the fireplace insert. The plates only need to be replaced when they begin to crumble after several years of use. The plates are only laid or placed into the fireplace insert, and can thus be replaced without problems by you or your dealer.

Removal of the combustion chamber lining is done in the following order.

1. Remove the flue deflector plates (1) by pushing the front upwards and pulling it forward so that the rear end is free. The smoke deflector can now be carefully removed.
2. Remove the smoke baffle plates (2) by pushing the front upwards and pulling it forward so that the rear is free. The smoke baffle plates can now be carefully removed.
3. The back plate (3) is removed by pulling out the bottom of the plate.
4. The bottom plates (4) are removed by first removing the grate and ash tray, see section Cleaning the combustion chamber. The base stones can then be removed.

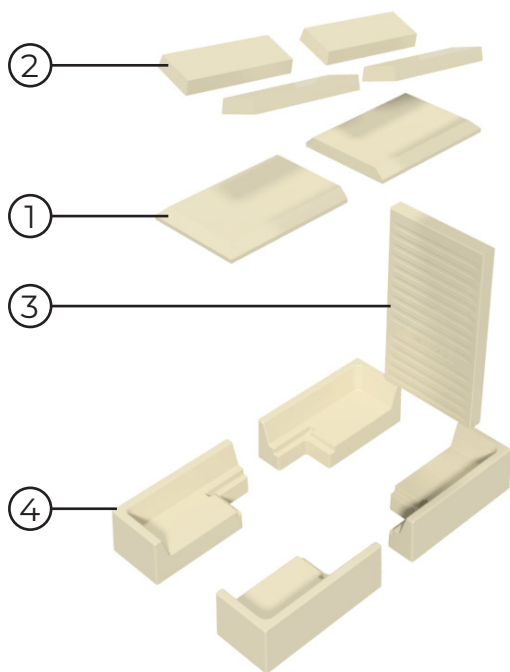

The MAX LOAD mark indicates that firewood must not be loaded above this line.

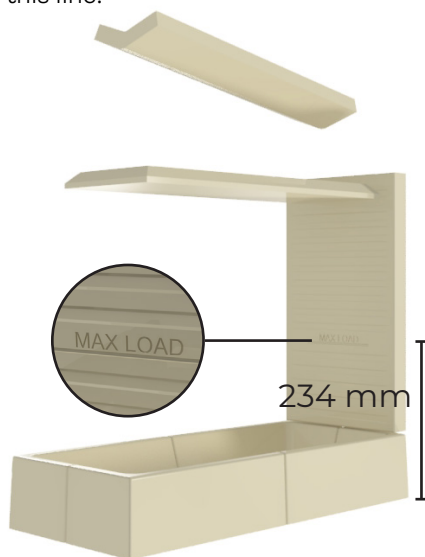

CLEANING THE FLUE

CLEANING THE FLUE

To gain access to the flue, remove the top plates of the firebox - the smoke deflector plate and smoke baffle. They must be handled carefully.

Remove dirt and dust and insert in reverse order.

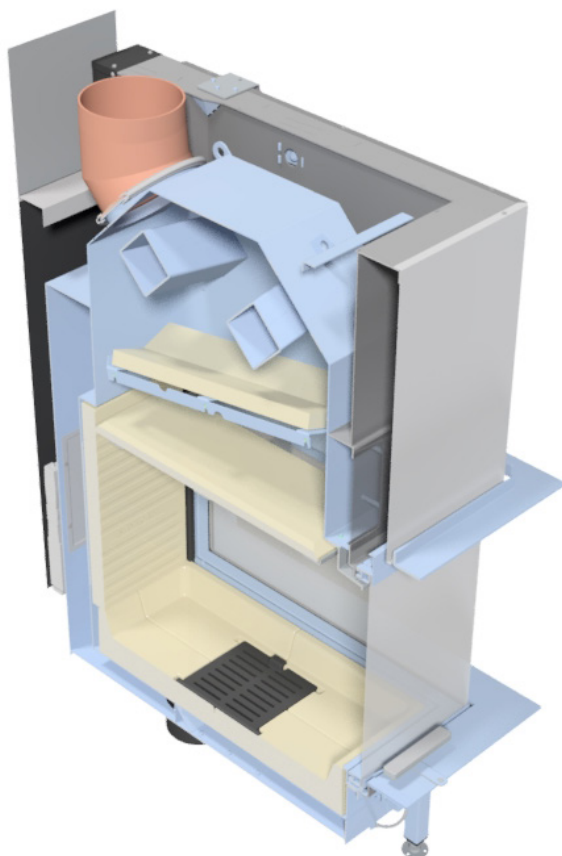

CHECKING THE CHIMNEY

The chimney is what makes your stove work. Remember – even the best stove will not work perfectly unless the chimney is drawing correctly and to the necessary extent. The chimney and flue gas collar must always be checked for blockages before each new heating season. Your chimney sweep should check both the chimney and your stove at least once a year. You should always contact your chimney sweep if you are in any doubt as regards the condition of your chimney.

If there your chimney is drawing too much, fitting the chimney or flue with a regulating damper is recommended. Contact your dealer.

MOVING PARTS

Guide rails for the lock are lubricated as needed with lubricating spray. Contact your dealer to purchase the lubricant.

REPLACING SEALS

Inspect your stove for damage regularly, both inside and out, in particular the seals and heat insulating plates. The seals must be replaced if they are worn or fractured.



FURNISHING DISTANCE

FURNISHING DISTANCE

There must be a certain distance from the stove's glass to combustible materials, such as furniture and other home furnishings. For safety reasons, it is important to observe these distances.

Minimum distance	mm
Distance from door to furniture	800
Distance from side glass to furniture insulated flue	600
Distance from side glass to furniture un-insulated flue	700

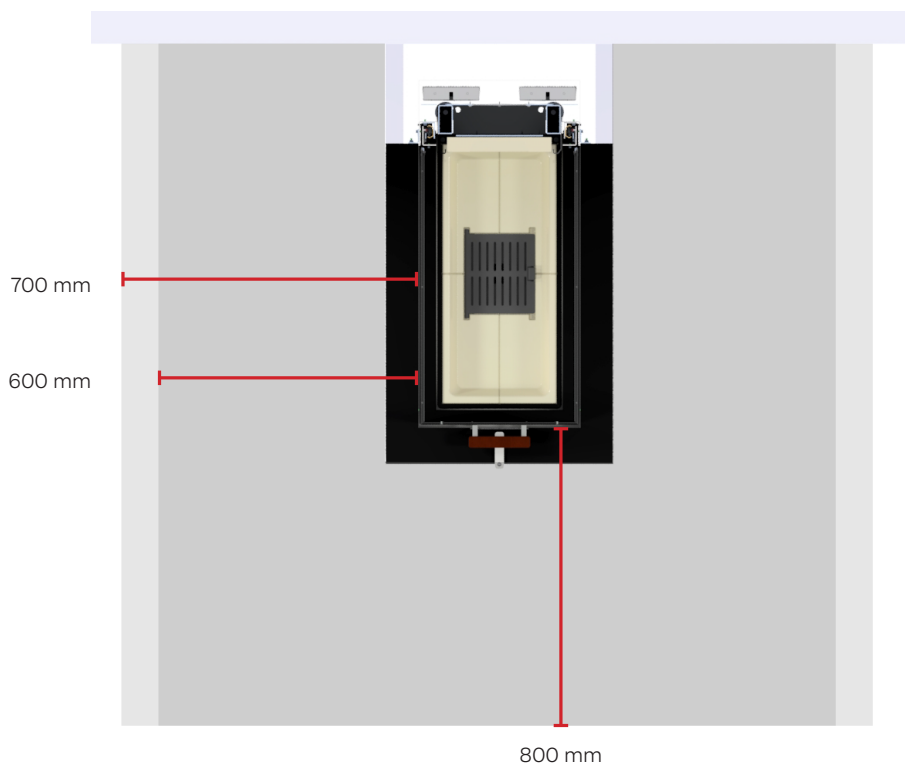

CONVECTION

All RAIS/attika stoves are convection stoves. Essentially, convection is all about the distribution of heat throughout the room. A convection stove is good at circulating hot air throughout the room. Cold air is drawn in at the base of the combustion chamber and heated. The hot air then rises and flows out at the top and creates circulation in the room. Convection ensures that heat is distributed evenly and comfortably throughout the room. Be aware that all exterior surfaces will be hot, so do not touch the stove when it is lit.

GLASS SYSTEM

All RAIS and attika stoves come with a glass system, which means that hot air flows down over the glass and removes any soot residues. This happens when the fire is burning correctly and there is a high level of combustion in the stove.

EXTERNAL AIR SUPPLY – AIRSYSTEM

If you live in a low-energy building, your home is insulated or you just live in a recently built house, you may find it necessary to provide an air supply from outside and directly into the stove. This may also be necessary if there is vigorous extraction near to your stove, such as an extractor hood. This external air supply is what we call AirSystem. All RAIS stoves have the option of providing an external air supply. If there is no external air supply, the stove uses air in the room for combustion instead. With AirSystem, the air is taken from outside. The system's air intake can be concealed by installing it in the floor, or in the wall behind the stove.

CO₂ AND THE ENVIRONMENT

You may also be wondering how your new stove will affect the environment, and not least your CO₂ emissions. Burning wood is regarded as CO₂-neutral, as the amount of carbon dioxide emitted when wood is burnt correctly is equivalent to the amount of carbon dioxide that the tree would have given off as it decayed in the forest.

As regards the environment, all RAIS stoves do of course meet the very strictest requirements in terms of efficiency and discharge of residual particles, and they are at the very front of the field in the European market when it comes to eco-friendliness. We are constantly working to develop and optimise combustion, and work in partnership with organisations such as Aalborg University and the Danish Technological Institute.

If you experience any minor problems with your stove, or if you are wondering about anything, you may perhaps find the answer below. But of course, if your question is not listed you are more than welcome to get in touch with us.

WHY IS MY STOVE NOT BURNING THE WAY IT SHOULD?

In most cases, we find that stoves do not burn the way they should because of the way they have been let. Please read the section entitled “General information on lighting your stove” carefully before getting started. There are three things in particular that cause stoves not to burn correctly:

- The damp is open too far (it should only be fully open during the initial phase, i.e. for 5-10 minutes).
- The door is opened too quickly after lighting the stove. Be patient and allow the fire to die down so that just glowing embers are left before you add more wood.
- You are not using enough wood, or the wood you are using is too thick or too wet. It will be difficult to get your chimney to draw if the wood is not burning as it should.

WHY IS MY STOVE MAKING “CLICKING NOISES”?

Little clicking noises are normal when the stove is in use. This is due to hot materials expanding.

WHY DOES THE GLASS TURN BLACK?

This may be because your wood is too wet or the damper on the stove is adjusted too far down. Check how damp your wood is, and make sure you give your stove enough air when lighting it before closing the door so that the stove warms up properly.

WHY IS SMOKE COMING OUT OF THE DOOR?

This may be because your chimney is not drawing properly. Check whether the flue or chimney is blocked. If your stove is situated near to the kitchen, check whether the extractor hood is switched on – if it is, switch it off and open a window near to the stove for a short time. This smoke may also appear if you open the door too quickly when adding new wood. Try opening the door more slowly.

WHY IS MY STOVE GIVING OFF AN ODOUR?

The stove may begin to give off smoke and odour if there is insufficient oxygen for combustion. Allow more air into your stove using the damper.

WHY IS MY STOVE GETTING TOO HOT?

You should not adjust your damper downwards if you find your stove is giving off too much heat in your room. The temperature can only be controlled by adjusting the amount of wood you use. Use less wood and vent the room.

WHY IS MY STOVE COVERED IN SOOT ON THE OUTSIDE, ABOVE THE DOOR?

Set on the outside of the stove is usually due to opening the door while there are still tall flames in the combustion chamber. Always wait until the fire has burned down before opening the door. This may also be caused by opening the door too quickly. Always open the door slowly and carefully. However, please be aware that it is not possible to prevent a small amount of ash and soot emerging when you use the stove.

WHY IS MY STOVE BURNING TOO FIERCELY?

If your stove is burning too fiercely, this may be due to a leak in the door seal. This has to be replaced as stated in the installation guide. It may also be due to your chimney drawing too much. In this case, a regulating damper should be fitted. You can ask a chimney sweep, fitter or dealer to come to your home and check whether your chimney is drawing correctly.

WHY IS MY STOVE NOT BURNING SUFFICIENTLY?

If your stove is not burning sufficiently, this may be due to several things: insufficient wood, insufficient supply of air to the ventilation in the room, failing to clean the flue, a leaking chimney or a leak between the chimney and the flue.

WHAT CAN I DO IF MY CHIMNEY IS NOT DRAWING PROPERLY?

If your chimney is failing to draw properly, this may be due to many different things:

- Too low a temperature difference – if your chimney is insulated poorly, for example.
- A high outdoor temperature (in summer, for example)
- No breeze
- The chimney is positioned too low and in a sheltered location
- The wrong air in the chimney
- The chimney and flue are blocked
- The house is too “sealed” (no fresh air supply)
- Negative smoke extraction (when the chimney is drawing poorly)

A cold chimney or difficult weather conditions can be compensated for by supplying more air to the stove than usual.

If your chimney is continuing to malfunction, we recommend that you contact your dealer or chimney sweep.

I AM ENCOUNTERING OTHER DIFFICULTIES WITH MY STOVE

Many queries or issues relating to the use of stoves are down to local conditions (such as draughts, for example) If you are experiencing a problem for which no answer is given here, please contact your RAIS/attika dealer.

GUARANTEE

RAIS or attika issues guarantee on all models, commencing from the date of installation. We have already invested a great deal of effort in our inspection processes and looked at the quality of materials, manufacture and product safety.

THE GUARANTEE DOES NOT COVER WEAR PARTS:

- Door and glass seals
- Ceramic glass
- Combustion chamber lining
- The surface appearance or the texture of natural stone
- The appearance of the stainless steel surfaces and colour changes
- Expansion blemishes

THE GUARANTEE WILL BE RENDERED VOID IF:

- Your stove has been damaged due to overfiring
- Damage has been caused by external stresses
- Unsuitable fuel types have been used
- There has been failure to comply with statutory or recommended installation instructions
- You have made alterations to the stove yourself
- Your stove has not been serviced or maintained

PLEASE CONTACT YOUR DEALER IF YOUR STOVE IS DAMAGED.

If you make a claim on the guarantee, we will decide on how the damage is to be remedied. If it is to be repaired, we will ensure that the repairs are carried out professionally.

Please see national and EU laws and regulations on renewed guarantee periods in the case of guarantees on repaired parts or parts supplied later. The applicable guarantee terms and conditions are available from RAIS or attika at any time.

RECYCLING

Oven er pakket i emballage som kan genbruges. Dette skal bortskaffes i henhold til national bestemmelse vedr. bortskaffelse af affald.

Glasset kan ikke genbruges. Glasset skal smides væk sammen med restaffald fra keramik og porcelæn. Ildfast glas har højere smeltetemperatur, og kan derfor ikke genbruges.

Når du sørger for at ildfast glas ikke havner i returprodukterne er det et vigtigt bidrag for miljøet.



TECHNICAL DATA

SPECIFICATIONS

Danish Technological Institute ref.: 300-ELAB-2646-EN

	VISIO UNIQ 3:1
Nominal output (kW)	11,3
Heating area (m ²)	180
Fireplace insert W x D x H (mm)	631 X 1062 X 1637
Combustion chamber W x D x H (mm)	237 X 638 X 234**
Min. flue draught (pascal)	-12
Weight (kg) min., depending on the model	318 kg
Efficiency (%)	76
CO emission attributed to 13% O ₂ (%)	0,0930 / 1162 mg/Nm ³
NOx emission attributed to 13% O ₂ (mg/Nm ³)	76
OGC emission attributed to 13% O ₂ (mg/Nm ³)	74
Particle emission in accordance with NS3058/3059 (g/kg)	6,57
Dust measurement in accordance with DIN + 13% O ₂ (mg/Nm ³)	36
Flue gas flow (g/s)	12,3
Flue gas temperature (°C)	262
Intended flue gas temperature (°C) at flue collar	314
Recommended wood volume (kg) for stoking the fire (Dispersed over three pieces of firewood)	3,0
Intermittent operation	Stoking should be done within 52 minutes

The fireplace insert was tested and approved by:

DTI

Danish Technological Institute

Teknologiparken Kongsvang Allé 29

8000 Aarhus C

Denmark

www.dti.dk

Tel.: +45 7220 2000, Fax: +45 7220 1019

*Not verified by test.

**Max. load

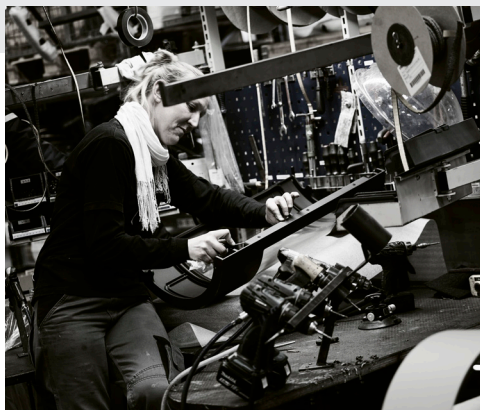

HAND-
CRAFTED
QUALITY





RAIS[®]
ART  OF FIRE

RAIS A/S
Industrivej 20
DK-9900 Frederikshavn
Denmark
www.rais.com

attika
FEUERKULTUR

ATTIKA FEUER AG
Brunnmatt 16
CH-6330 Cham
Switzerland
www.attika.ch

